

MWX201 PCB Spring Type Terminal Block

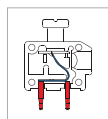

DIMENSIONS/POSITIONS

MWX201-762

間距	Pitch	7.62mm
位數	Poles	2 ~ 20Poles
塑膠本體	Housing Material	PA 66
端蓋	Cover	PA 66
端子	Contact	Brass, Tin Plated
彈片	Spring	Stainless Strip Steel
電線線徑	Wire Size	14 ~ 20AWG
剝線長度	Wire Strip Length	9mm ~ 10mm
PCB孔徑	PCB Hole Diameter	1.2mm
環境作業溫度	Operating Temperature	-40°C to +105°C

TECHNICAL DATA

連接符合標準 Connection in acc. with standard EN-VDE		
額定電流 I _n Nominal Current I _n		10A
額定橫截面 Nominal Cross Section		-
最大負載電流 Maximum load current		10A
絕緣材料 Insulating Material		PA
阻燃等級,符合UL94 Inflammability class acc. to UL94		V0
額定電壓,UL/CUL Nominal voltage, UL/CUL		300V
額定電流,UL/CUL Nominal current, UL/CUL		10A

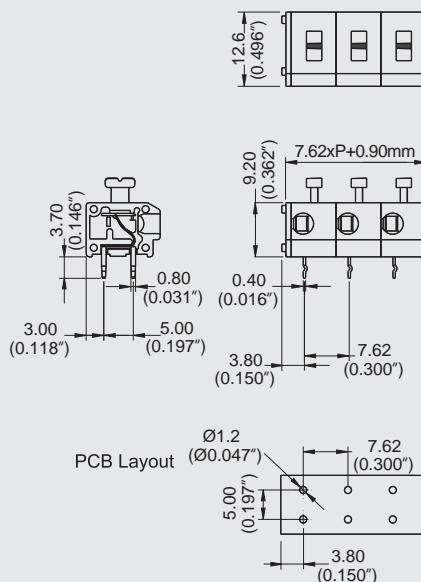

MWX