

.250" PCB Barrier Terminal Blocks

TYPE:T30M

Modular(モジュール式)

Pitch:6.35mm

T30MBS11-04

Terminal style: S11

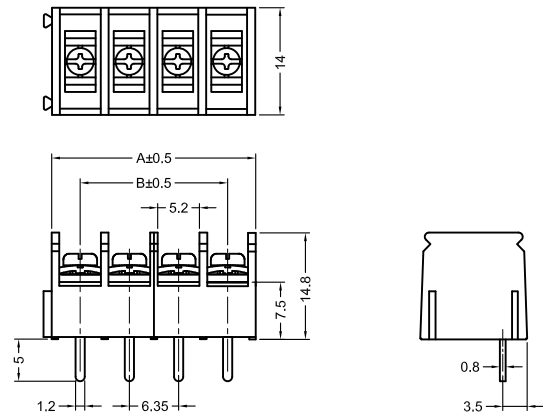
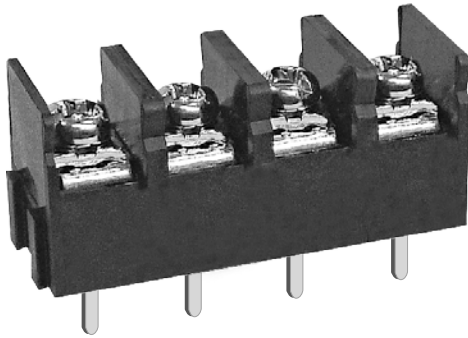

T30MBS64-04

Terminal style: S64

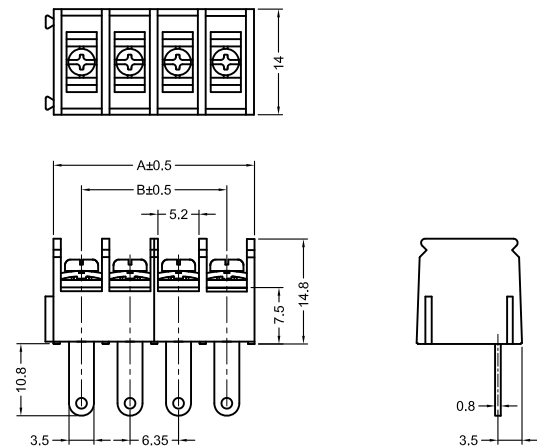
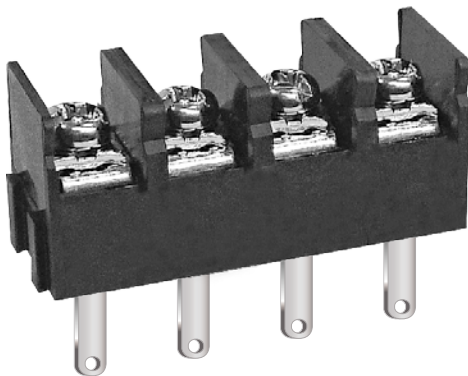

Poles	2	3	4	5	6	7	8	9	10	11	12	13	14	15	16
A(mm)	13.70	20.05	26.40	32.75	39.10	45.45	51.80	58.15	64.50	70.85	77.20	83.55	89.90	96.25	102.60
B(mm)	6.35	12.70	19.05	25.40	31.75	38.10	44.45	50.80	57.15	63.50	69.85	76.20	82.55	88.90	95.25
Poles	17	18	19	20	21	22	23	24	25	26	27	28	29	30	
A(mm)	108.95	115.30	121.65	128.00	134.35	140.70	147.05	153.40	159.75	166.10	172.45	178.80	185.15	191.50	
B(mm)	101.60	107.95	114.30	120.65	127.00	133.35	139.70	146.05	152.40	158.75	165.10	171.45	177.80	184.15	

.250" PCB Barrier Terminal Blocks

DECA[®]
SwitchLab

TYPE:T30M (貫通式端子台)

Modular(モジュール式)

Pitch:6.35mm

T30MBS11-02

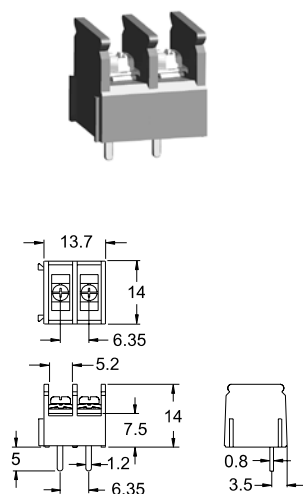

T30MBS11-03

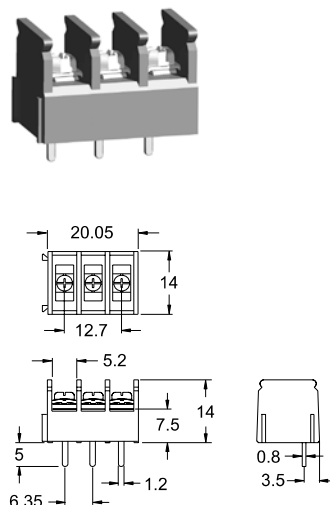

T30MRS11-02

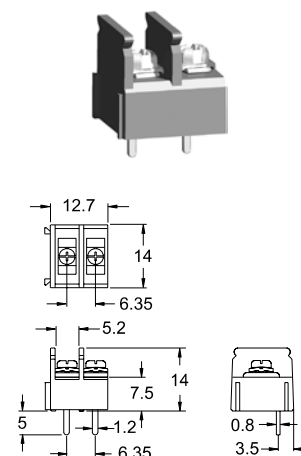

T30MRS11-03

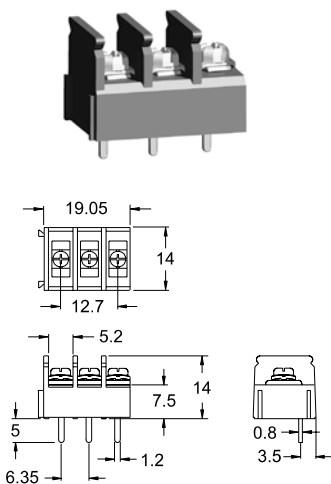

T30M-R01

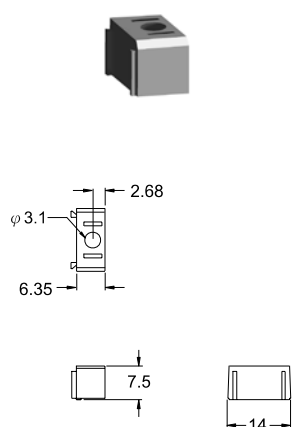



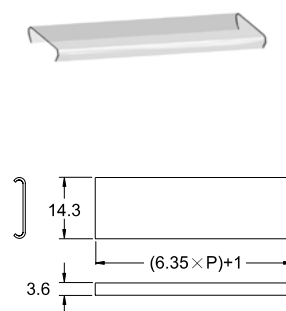























































BC30M-□□



T30MBS11-02		2 pole modular
T30MBS11-03		3 pole modular
T30MRS11-02		2 pole modular w/o wall (right side)
T30MRS11-03		3 pole modular w/o wall (right side)
T30M-R01		mounting hole
BC30M-□□		clear cover

ORDER GUIDE

Housing	Assemble Breakdown			
 T30MBS11-02	 T30MBS11-02			
 T30MBS11-03	 T30MBS11-03			
 T30MBS11-04	 T30MRS11-02	 T30MBS11-02		
 T30MBS11-05	 T30MRS11-02	 T30MBS11-03		
 T30MBS11-06	 T30MRS11-03	 T30MBS11-03		
 T30MBS11-07	 T30MRS11-02	 T30MRS11-02	 T30MBS11-03	
 T30MBS11-08	 T30MRS11-02	 T30MRS11-03	 T30MBS11-03	
 T30MBS11-09	 T30MRS11-03	 T30MRS11-03	 T30MBS11-03	
 T30MBS11-10	 T30MRS11-02	 T30MRS11-02	 T30MRS11-03	 T30MBS11-03
 T30MBS11-11	 T30MRS11-02	 T30MRS11-03	 T30MRS11-03	 T30MBS11-03
 T30MBS11-12	 T30MRS11-03	 T30MRS11-03	 T30MRS11-03	 T30MBS11-03
 T30MOS11-02	 T30M-R01	 T30MBS11-02	 T30M-R01	
 T30MOS11-03	 T30M-R01	 T30MBS11-03	 T30M-R01	
 T30MOS11-04	 T30M-R01	 T30MRS11-02	 T30MBS11-02	 T30M-R01
 T30MOS11-05	 T30M-R01	 T30MRS11-02	 T30MBS11-03	 T30M-R01