

TYPE:T35 (貫通式端子台)

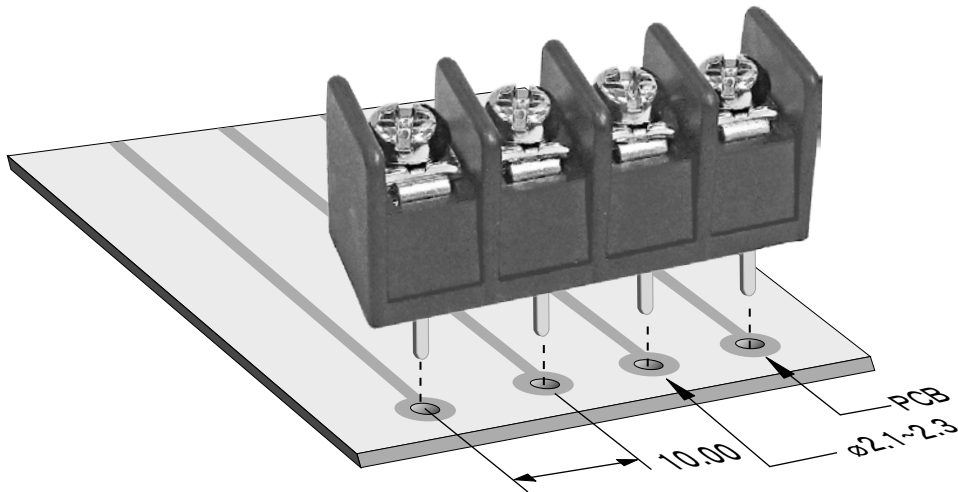

Pitch:10.00mm



ORDER GUIDE(注文方法):

T35 - B M11 - 04

Body(本体)		Terminal style(端子スタイル)		Poles(極数)
<p>A: 取付穴・壁有り、カバー無し (Mount Ends)</p>	<p>E: 取付穴無し、壁有り、 カバー付き (Barrier Ends with Cover)</p>	M11		02
				⋮
B: 取付穴・カバー無し、壁有り (Barrier Ends)	K: 取付穴・壁有り、カバー付き (Mount Ends and Cover)	M14		⋮
				⋮
C: 取付穴有り、金具・壁無し、 カバー付き (Mount with Cover)	L: 取付穴有り、金具・壁・ カバー無し、金具ガイド付き (Mount Ends with Standoffs)	M22		⋮
				⋮
D: 取付穴・カバー無し、壁有り、 金具ガイド付き (Barrier Ends with Standoffs)	N: 取付穴有り、金具・壁無し、 カバー・金具ガイド付き (Mount Ends with Standoffs and Cover)			30
				⋮

.394" PCB Barrier Terminal Blocks

TYPE:T35

Pitch:10.00mm

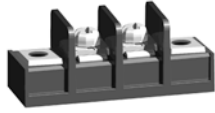
Body(本体)	Terminal style(端子スタイル)	Poles(極数)
<p>O: 取付穴有り、金具・壁・カバー無し (Mount Ends) W: 取付穴・カバー有り、壁無し (Without wall・with metals and Cover)</p> 		02 ⋮ 30
<p>R: 取付穴有り、壁・カバー無し (Without wall・with metals)</p> 		

SPECIFICATION(規格,仕様):

Terminal :	Brass, Tin plated,0.8 t	端子金具 :	黄銅板ハンダメッキ,0.8 t
Insulator body :	PBT(UL94V-0), Black	本体 :	PBT(UL94V-0), 黒色
Screw :	M3.5, steel, Ni plated	端子ネジ :	M3.5, 鉄ニッケルメッキ
Cover :	PC	カバー :	PC
Operation temperatures :	-40° C to +120° C	使用温度範囲 :	-40° C to +120° C
Rated current :	20Amp 300V	定格 :	20Amp 300V
Insulation withstands volt :	2000V 1min	耐電圧 :	2000V 一分間
Insulation resistance :	2000MΩ at DC 500V	絶縁抵抗 :	DC500V 2000MΩ
PCB hole Dia :	ø 2.1mm~ø 2.3mm	基板穴径 :	ø 2.1mm~ø 2.3mm
Wire range :	14~22 AWG	適合電線 :	14~22 AWG
Screw torque :	16 lb-in Screw with washer	締付トルク :	16 lb-in ワッシャー付ネジ

T35-BM11-04

Terminal style:M11

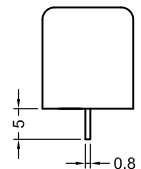
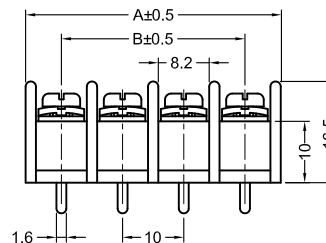
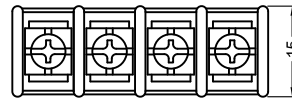
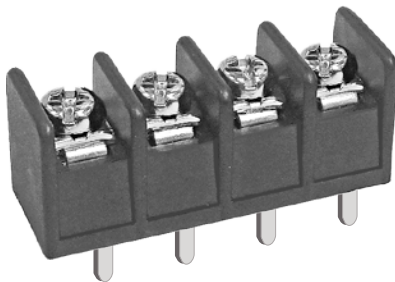

Poles	2	3	4	5	6	7	8	9	10	11	12	13	14	15	16
A(mm)	21.80	31.80	41.80	51.80	61.80	71.80	81.80	91.80	101.80	111.80	121.80	131.80	141.80	151.80	161.80
B(mm)	10.00	20.00	30.00	40.00	50.00	60.00	70.00	80.00	90.00	100.00	110.00	120.00	130.00	140.00	150.00
Poles	17	18	19	20	21	22	23	24	25	26	27	28	29	30	
A(mm)	171.80	181.80	191.80	201.80	211.80	221.80	231.80	241.80	251.80	261.80	271.80	281.80	291.80	301.80	
B(mm)	160.00	170.00	180.00	190.00	200.00	210.00	220.00	230.00	240.00	250.00	260.00	270.00	280.00	290.00	

.394" PCB Barrier Terminal Blocks

TYPE:T35

Pitch:10.00mm

T35-BM14-04

Terminal style:M14

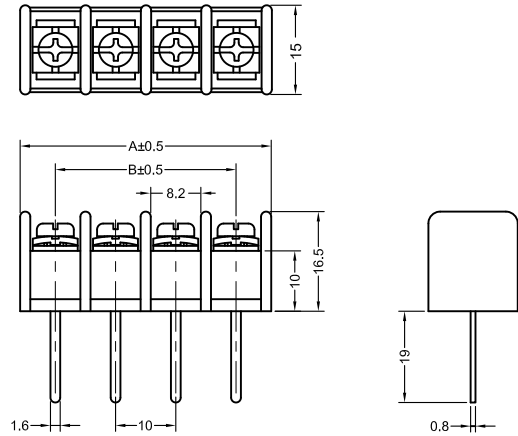

T35-BM22-04

Terminal style:M22

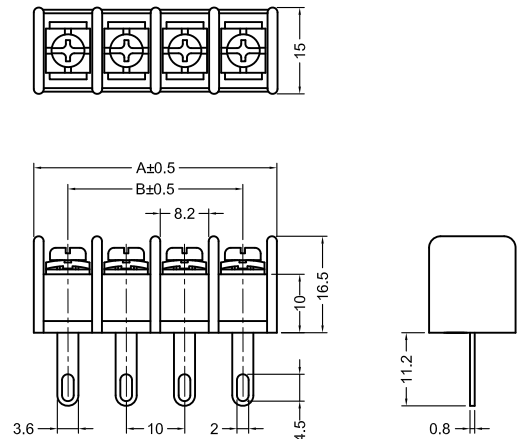

T35-BM32-04

Terminal style:M32

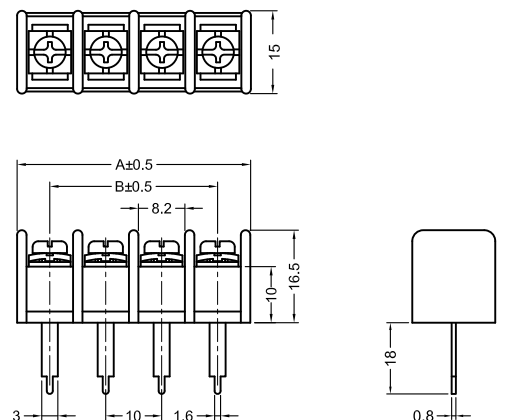
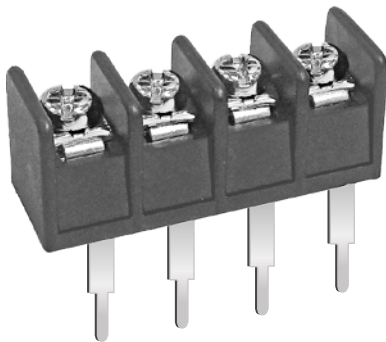

Poles	2	3	4	5	6	7	8	9	10	11	12	13	14	15	16
A(mm)	21.80	31.80	41.80	51.80	61.80	71.80	81.80	91.80	101.80	111.80	121.80	131.80	141.80	151.80	161.80
B(mm)	10.00	20.00	30.00	40.00	50.00	60.00	70.00	80.00	90.00	100.00	110.00	120.00	130.00	140.00	150.00
Poles	17	18	19	20	21	22	23	24	25	26	27	28	29	30	
A(mm)	171.80	181.80	191.80	201.80	211.80	221.80	231.80	241.80	251.80	261.80	271.80	281.80	291.80	301.80	
B(mm)	160.00	170.00	180.00	190.00	200.00	210.00	220.00	230.00	240.00	250.00	260.00	270.00	280.00	290.00	

.394" PCB Barrier Terminal Blocks

TYPE:T35

Pitch:10.00mm

T35-BO32-04

Terminal style:O32

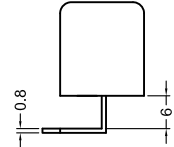
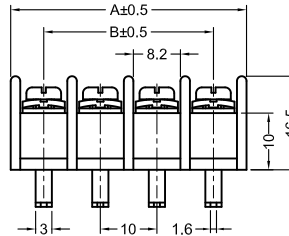
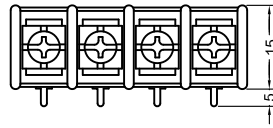
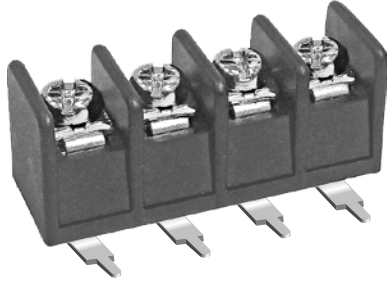

T35-BS11-04

Terminal style:S11

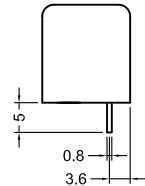
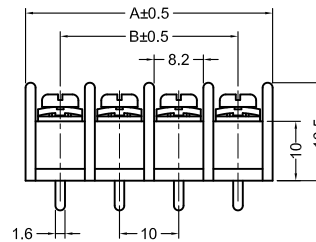
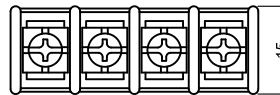

Poles	2	3	4	5	6	7	8	9	10	11	12	13	14	15	16
A(mm)	21.80	31.80	41.80	51.80	61.80	71.80	81.80	91.80	101.80	111.80	121.80	131.80	141.80	151.80	161.80
B(mm)	10.00	20.00	30.00	40.00	50.00	60.00	70.00	80.00	90.00	100.00	110.00	120.00	130.00	140.00	150.00
Poles	17	18	19	20	21	22	23	24	25	26	27	28	29	30	
A(mm)	171.80	181.80	191.80	201.80	211.80	221.80	231.80	241.80	251.80	261.80	271.80	281.80	291.80	301.80	
B(mm)	160.00	170.00	180.00	190.00	200.00	210.00	220.00	230.00	240.00	250.00	260.00	270.00	280.00	290.00	