

開關構造說明 (Switch Construction Instructions)

按鈕開關 (Pushbuttons)

A20

按鈕開關
(Pushbuttons)
Page.24-28

按鈕開關操作部
(Pushbutton Operators)
Page.121-123

燈罩
(Lens)
Page.142

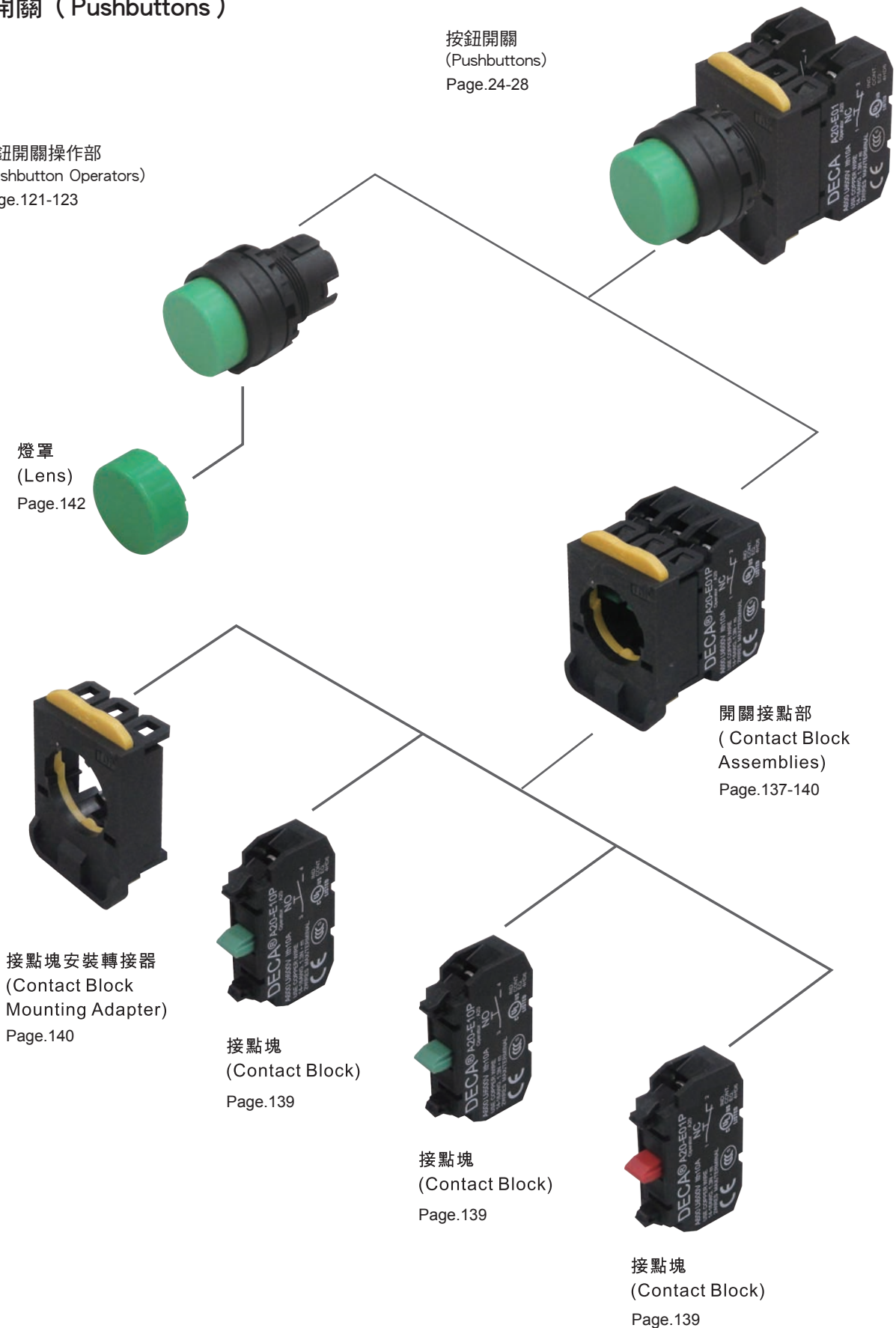

開關接點部
(Contact Block
Assemblies)
Page.137-140

接點塊安裝轉接器
(Contact Block
Mounting Adapter)
Page.140

接點塊
(Contact Block)
Page.139

接點塊
(Contact Block)
Page.139

接點塊
(Contact Block)
Page.139

按鈕開關 (Pushbuttons)

平頭形 (Flush)



20B

燈泡 (Illumination Type)	動作類型 (Operation)	接點結構 (Contacts)	型號 (Type No.)	使用電壓記號 (Operating Voltage Code)	顏色記號① (Lens Color Code①)
無 (Without Lamp)	瞬時型 (Momentary)	1NO	A20B-M1E10①	無燈泡 (Without Lamp)	B : 黑色 G : 綠色 R : 紅色 S : 藍色 W : 白色 Y : 黃色 B : black G : green R : red S : blue W : white Y : yellow
		1NC	A20B-M1E01①		
		2NO	A20B-M1E20①		
		2NC	A20B-M1E02①		
		1NO-1NC	A20B-M1E11①		
		3NO	A20B-M1E30①		
		3NC	A20B-M1E03①		
		2NO-1NC	A20B-M1E21①		
		1NO-2NC	A20B-M1E12①		
	交替型 (Maintained)	1NO	A20B-A1E10①		
		1NC	A20B-A1E01①		
		2NO	A20B-A1E20①		
		2NC	A20B-A1E02①		
		1NO-1NC	A20B-A1E11①		

■外型尺寸(Dimensions) mm

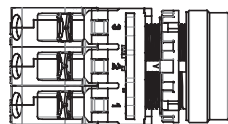

面板厚度 (Panel Thickness)
0.8~6

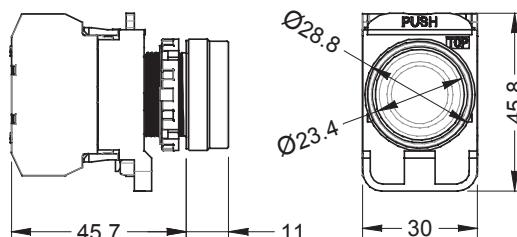

按鈕開關 (Pushbuttons)

凸頭形 (Extended)

A20



燈泡 (Illumination Type)	動作類型 (Operation)	接點結構 (Contacts)	型號 (Type No.)	使用電壓記號 (Operating Voltage Code)	顏色記號① (Lens Color Code①)
無 (Without Lamp)	瞬時型 (Momentary)	1NO	A20B-M2E10①	無燈泡 (Without Lamp)	B : 黑色 G : 綠色 R : 紅色 S : 藍色 W : 白色 Y : 黃色 B : black G : green R : red S : blue W : white Y : yellow
		1NC	A20B-M2E01①		
		2NO	A20B-M2E20①		
		2NC	A20B-M2E02①		
		1NO-1NC	A20B-M2E11①		
	交替型 (Maintained)	1NO	A20B-A2E10①		
		1NC	A20B-A2E01①		
		2NO	A20B-A2E20①		
		2NC	A20B-A2E02①		
		1NO-1NC	A20B-A2E11①		

■外型尺寸(Dimensions) mm



面板厚度 (Panel Thickness)
0.8~6

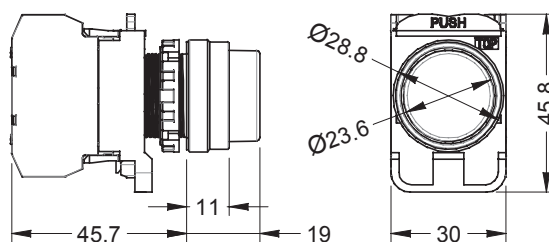

按鈕開關 (Pushbuttons)

全護圈凸頭形 (Extended with Full Shroud)



20B

燈泡 (Illumination Type)	動作類型 (Operation)	接點結構 (Contacts)	型號 (Type No.)	使用電壓記號 (Operating Voltage Code)	顏色記號① (Lens Color Code①)
無 (Without Lamp)	瞬時型 (Momentary)	1NO	A20B-MF2E10①	無燈泡 (Without Lamp)	B : 黑色 G : 綠色 R : 紅色 S : 藍色 W : 白色 Y : 黃色
		1NC	A20B-MF2E01①		
		2NO	A20B-MF2E20①		
		2NC	A20B-MF2E02①		
		1NO-1NC	A20B-MF2E11①		
	交替型 (Maintained)	1NO	A20B-AF2E10①		
		1NC	A20B-AF2E01①		
		2NO	A20B-AF2E20①		
		2NC	A20B-AF2E02①		
		1NO-1NC	A20B-AF2E11①		

■外型尺寸(Dimensions) mm



面板厚度 (Panel Thickness)
0.8~6

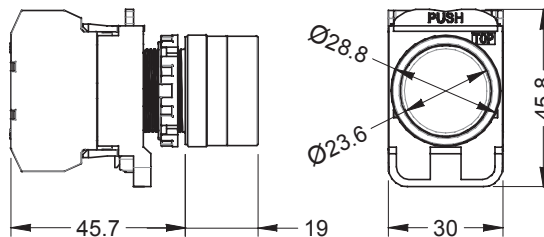

按鈕開關 (Pushbuttons)

φ 40mm 蘑菇頭形 (Mushroom φ 40mm)

A20



燈泡 (Illumination Type)	動作類型 (Operation)	接點結構 (Contacts)	型號 (Type No.)	使用電壓記號 (Operating Voltage Code)	顏色記號① (Lens Color Code①)
無 (Without Lamp)	瞬時型 (Momentary)	1NO	A20B-M4E10①	無燈泡 (Without Lamp)	B : 黑色 G : 綠色 R : 紅色 S : 藍色 W : 白色 Y : 黃色
		1NC	A20B-M4E01①		
		2NO	A20B-M4E20①		
		2NC	A20B-M4E02①		
		1NO-1NC	A20B-M4E11①		
	交替型 (Maintained)	1NO	A20B-A4E10①		
		1NC	A20B-A4E01①		
		2NO	A20B-A4E20①		
		2NC	A20B-A4E02①		
		1NO-1NC	A20B-A4E11①		
					B : black G : green R : red S : blue W : white Y : yellow

■外型尺寸(Dimensions) mm

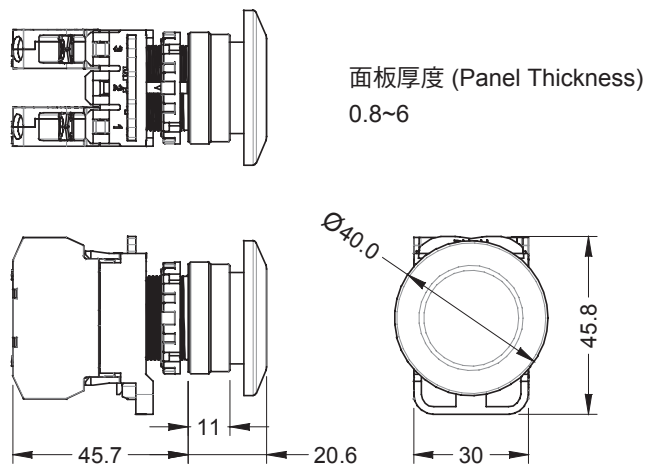

開關構造說明 (Switch Construction Instructions)

金屬鑲嵌框按鈕開關 (Pushbuttons)

A204B

按鈕開關
(Pushbuttons)
Page.63-72

按鈕開關操作部
(Pushbutton Operators)
Page.122-123



燈罩
(Lens)
Page.142



開關接點部
(Contact Block Assemblies)
Page.137-140



接點塊安裝轉接器
(Contact Block Mounting Adapter)
Page.140



接點塊
(Contact Block)
Page.139



接點塊
(Contact Block)
Page.139



接點塊
(Contact Block)
Page.139



Ø22 A20 系列控制元件 (Metal Bezels)

按鈕開關 (Pushbuttons)

金屬框平頭形 (Flush with Low Metal Bezel)

A204B



燈泡 (Illumination Type)	動作類型 (Operation)	接點結構 (Contacts)	型號 (Type No.)	使用電壓記號 (Operating Voltage Code)	顏色記號① (Lens Color Code①)
無 (Without Lamp)	瞬時型 (Momentary)	1NO	A204B-M1E10①	無燈泡 (Without Lamp)	B : 黑色 G : 綠色 R : 紅色 S : 藍色 W : 白色 Y : 黃色 B : black G : green R : red S : blue W : white Y : yellow
		1NC	A204B-M1E01①		
		2NO	A204B-M1E20①		
		2NC	A204B-M1E02①		
		1NO-1NC	A204B-M1E11①		
		3NO	A204B-M1E30①		
		3NC	A204B-M1E03①		
		2NO-1NC	A204B-M1E21①		
		1NO-2NC	A204B-M1E12①		
	交替型 (Maintained)	1NO	A204B-A1E10①		
		1NC	A204B-A1E01①		
		2NO	A204B-A1E20①		
		2NC	A204B-A1E02①		
		1NO-1NC	A204B-A1E11①		

■ 外型尺寸 (Dimensions) mm

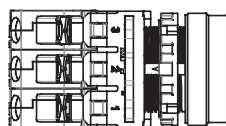

面板厚度 (Panel Thickness)
0.8~6

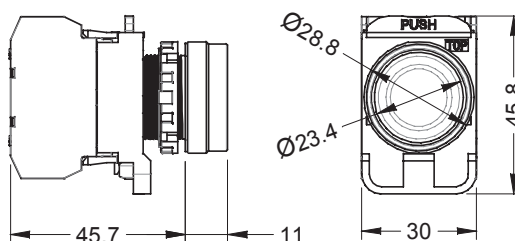

按鈕開關 (Pushbuttons)

金屬框平頭形 (Flush with High Metal Bezel)



A204B

燈泡 (Illumination Type)	動作類型 (Operation)	接點結構 (Contacts)	型號 (Type No.)	使用電壓記號 (Operating Voltage Code)	顏色記號① (Lens Color Code①)
無 (Without Lamp)	瞬時型 (Momentary)	1NO	A204B-M1E10①-B	無燈泡 (Without Lamp)	B : 黑色 G : 綠色 R : 紅色 S : 藍色 W : 白色 Y : 黃色
		1NC	A204B-M1E01①-B		
		2NO	A204B-M1E20①-B		
		2NC	A204B-M1E02①-B		
		1NO-1NC	A204B-M1E11①-B		
	交替型 (Maintained)	1NO	A204B-A1E10①-B		
		1NC	A204B-A1E01①-B		
		2NO	A204B-A1E20①-B		
		2NC	A204B-A1E02①-B		
		1NO-1NC	A204B-A1E11①-B		

■外型尺寸(Dimensions) mm



面板厚度 (Panel Thickness)

0.8~6

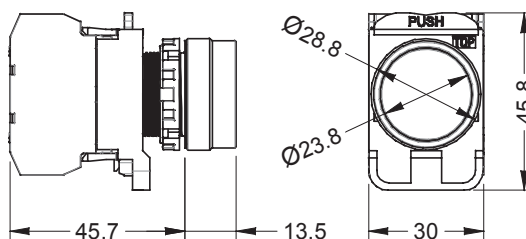

按鈕開關 (Pushbuttons)

金屬鑲嵌框圓形平頭 (Flush with High Metal Silhouette)

A204B



燈泡 (Illumination Type)	動作類型 (Operation)	接點結構 (Contacts)	型號 (Type No.)	使用電壓記號 (Operating Voltage Code)	顏色記號① (Lens Color Code①)
無 (Without Lamp)	瞬時型 (Momentary)	1NO	A204B-M1E10①-BU	無燈泡 (Without Lamp)	B : 黑色 G : 綠色 R : 紅色 S : 藍色 W : 白色 Y : 黃色 B : black G : green R : red S : blue W : white Y : yellow
		1NC	A204B-M1E01①-BU		
		2NO	A204B-M1E20①-BU		
		2NC	A204B-M1E02①-BU		
		1NO-1NC	A204B-M1E11①-BU		
	交替型 (Maintained)	1NO	A204B-A1E10①-BU		
		1NC	A204B-A1E01①-BU		
		2NO	A204B-A1E20①-BU		
		2NC	A204B-A1E02①-BU		
		1NO-1NC	A204B-A1E11①-BU		

■外型尺寸(Dimensions) mm

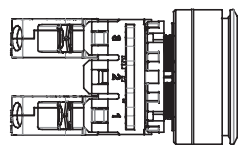

面板厚度 (Panel Thickness)
0.8~6

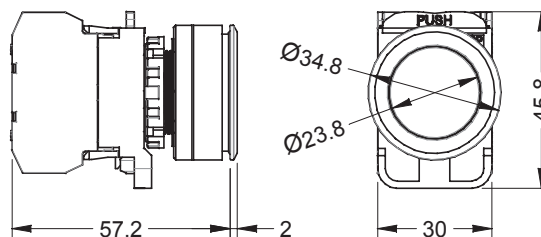

按鈕開關 (Pushbuttons)

金屬鑲嵌框圓形平頭 (Flush with Low Metal Silhouette)



A204B

燈泡 (Illumination Type)	動作類型 (Operation)	接點結構 (Contacts)	型號 (Type No.)	使用電壓記號 (Operating Voltage Code)	顏色記號① (Lens Color Code①)
無 (Without Lamp)	瞬時型 (Momentary)	1NO	A204B-M1E10①-U	無燈泡 (Without Lamp)	B : 黑色 G : 綠色 R : 紅色 S : 藍色 W : 白色 Y : 黃色 B : black G : green R : red S : blue W : white Y : yellow
		1NC	A204B-M1E01①-U		
		2NO	A204B-M1E20①-U		
		2NC	A204B-M1E02①-U		
		1NO-1NC	A204B-M1E11①-U		
		3NO	A204B-M1E30①-U		
		3NC	A204B-M1E03①-U		
		2NO-1NC	A204B-M1E21①-U		
		1NO-2NC	A204B-M1E12①-U		
	交替型 (Maintained)	1NO	A204B-A1E10①-U		
		1NC	A204B-A1E01①-U		
		2NO	A204B-A1E20①-U		
		2NC	A204B-A1E02①-U		
		1NO-1NC	A204B-A1E11①-U		

■外型尺寸(Dimensions) mm

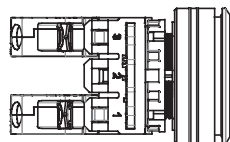

面板厚度 (Panel Thickness)
0.8~6

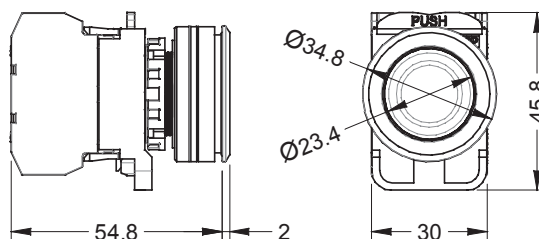

Ø22 A20 系列控制元件 (Metal Bezels)

按鈕開關 (Pushbuttons)

金屬框凸頭形 (Extended with Metal Bezel)

A204B



燈泡 (Illumination Type)	動作類型 (Operation)	接點結構 (Contacts)	型號 (Type No.)	使用電壓記號 (Operating Voltage Code)	顏色記號① (Lens Color Code①)
無 (Without Lamp)	瞬時型 (Momentary)	1NO	A204B-M2E10①	無燈泡 (Without Lamp)	B : 黑色 G : 綠色 R : 紅色 S : 藍色 W : 白色 Y : 黃色 B : black G : green R : red S : blue W : white Y : yellow
		1NC	A204B-M2E01①		
		2NO	A204B-M2E20①		
		2NC	A204B-M2E02①		
		1NO-1NC	A204B-M2E11①		
	交替型 (Maintained)	1NO	A204B-A2E10①		
		1NC	A204B-A2E01①		
		2NO	A204B-A2E20①		
		2NC	A204B-A2E02①		
		1NO-1NC	A204B-A2E11①		

■外型尺寸(Dimensions) mm



面板厚度 (Panel Thickness)
0.8~6

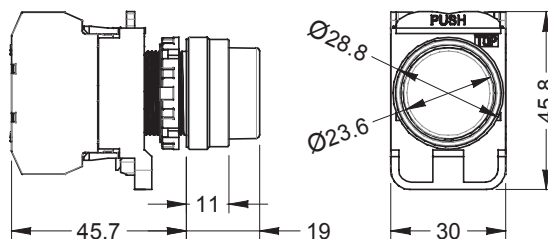

按鈕開關 (Pushbuttons)

金屬鑲嵌框凸頭形 (Extended with Low Metal Silhouette)



A204B

燈泡 (Illumination Type)	動作類型 (Operation)	接點結構 (Contacts)	型號 (Type No.)	使用電壓記號 (Operating Voltage Code)	顏色記號① (Lens Color Code①)
無 (Without Lamp)	瞬時型 (Momentary)	1NO	A204B-M2E10①-U	無燈泡 (Without Lamp)	B : 黑色 G : 綠色 R : 紅色 S : 藍色 W : 白色 Y : 黃色
		1NC	A204B-M2E01①-U		
		2NO	A204B-M2E20①-U		
		2NC	A204B-M2E02①-U		
		1NO-1NC	A204B-M2E11①-U		
	交替型 (Maintained)	1NO	A204B-A2E10①-U		
		1NC	A204B-A2E01①-U		
		2NO	A204B-A2E20①-U		
		2NC	A204B-A2E02①-U		
		1NO-1NC	A204B-A2E11①-U		

■外型尺寸(Dimensions) mm

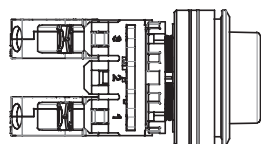

面板厚度 (Panel Thickness)

0.8~6

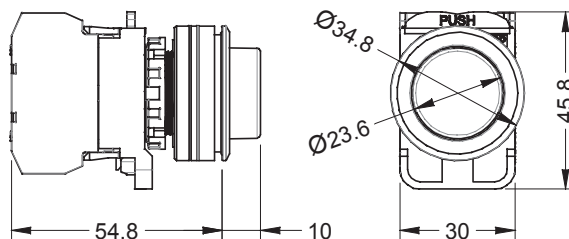

Ø22 A20 系列控制元件 (Metal Bezels)

按鈕開關 (Pushbuttons)

全護圈金屬框凸頭形 (Extended with Metal Bezel & Full Shroud)

A204B

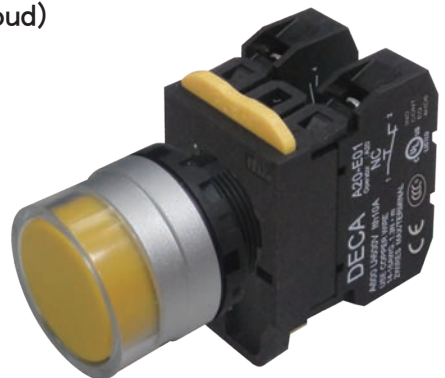

燈泡 (Illumination Type)	動作類型 (Operation)	接點結構 (Contacts)	型號 (Type No.)	使用電壓記號 (Operating Voltage Code)	顏色記號① (Lens Color Code①)
無 (Without Lamp)	瞬時型 (Momentary)	1NO	A204B-MF2E10①	無燈泡 (Without Lamp)	B : 黑色 G : 綠色 R : 紅色 S : 藍色 W : 白色 Y : 黃色 B : black G : green R : red S : blue W : white Y : yellow
		1NC	A204B-MF2E01①		
		2NO	A204B-MF2E20①		
		2NC	A204B-MF2E02①		
		1NO-1NC	A204B-MF2E11①		
	交替型 (Maintained)	1NO	A204B-AF2E10①		
		1NC	A204B-AF2E01①		
		2NO	A204B-AF2E20①		
		2NC	A204B-AF2E02①		
		1NO-1NC	A204B-AF2E11①		

■外型尺寸(Dimensions) mm



面板厚度 (Panel Thickness)
0.8~6

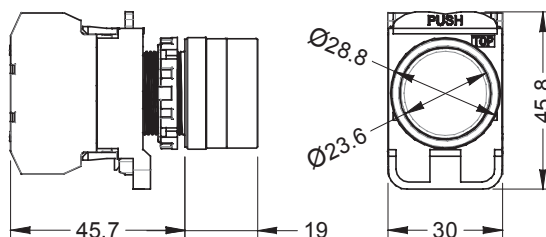

按鈕開關 (Pushbuttons)

φ 40mm金屬框蘑菇頭形 (Mushroom φ 40mm with Metal Bezel)



A204B

燈泡 (Illumination Type)	動作類型 (Operation)	接點結構 (Contacts)	型號 (Type No.)	使用電壓記號 (Operating Voltage Code)	顏色記號① (Lens Color Code①)
無 (Without Lamp)	瞬時型 (Momentary)	1NO	A204B-M4E10①	無燈泡 (Without Lamp)	B : 黑色 G : 綠色 R : 紅色 S : 藍色 W : 白色 Y : 黃色
		1NC	A204B-M4E01①		
		2NO	A204B-M4E20①		
		2NC	A204B-M4E02①		
		1NO-1NC	A204B-M4E11①		
	交替型 (Maintained)	1NO	A204B-A4E10①		
		1NC	A204B-A4E01①		
		2NO	A204B-A4E20①		
		2NC	A204B-A4E02①		
		1NO-1NC	A204B-A4E11①		

■外型尺寸(Dimensions) mm

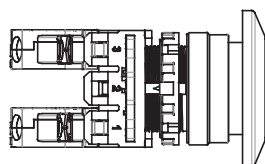

面板厚度 (Panel Thickness)
0.8~6

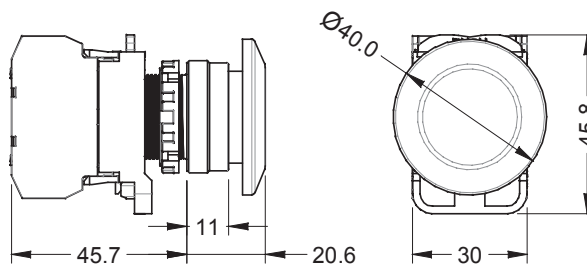

Ø22 A20 系列控制元件 (Metal Bezels)

按鈕開關 (Pushbuttons)

φ 40mm 金屬框蘑菇頭形 (Mushroom φ 40mm with Low Metal Silhouette)

A204B



燈泡 (Illumination Type)	動作類型 (Operation)	接點結構 (Contacts)	型號 (Type No.)	使用電壓記號 (Operating Voltage Code)	顏色記號① (Lens Color Code①)
無 (Without Lamp)	瞬時型 (Momentary)	1NO	A204B-M4E10①-U	無燈泡 (Without Lamp)	B : 黑色 G : 綠色 R : 紅色 S : 藍色 W : 白色 Y : 黃色 B : black G : green R : red S : blue W : white Y : yellow
		1NC	A204B-M4E01①-U		
		2NO	A204B-M4E20①-U		
		2NC	A204B-M4E02①-U		
		1NO-1NC	A204B-M4E11①-U		
	交替型 (Maintained)	1NO	A204B-A4E10①-U		
		1NC	A204B-A4E01①-U		
		2NO	A204B-A4E20①-U		
		2NC	A204B-A4E02①-U		
		1NO-1NC	A204B-A4E11①-U		

■外型尺寸(Dimensions) mm

