

開關構造說明 (Switch Construction Instructions)

A20K

鑰匙選擇開關 (Key Selector Switches)

鑰匙選擇開關操作部
(Key Selector Switches
Operators)
Page.128



鑰匙選擇開關
(Key Selector Switches)
Page.57-62



開關接點部
(Contact Block
Assemblies)
Page.137-140



接點塊安裝轉接器
(Contact Block
Mounting Adapter)
Page.140



接點塊
(Contact Block)
Page.139



接點塊
(Contact Block)
Page.139



接點塊
(Contact Block)
Page.139



鑰匙選擇開關 (Key Selector Switches)

90° -2位置 / 交替型標準旋鈕 (90° -2 Position / Knob Type with Maintained)



A20K

位置數 (No. of Positions)	接點結構 (Contacts)			旋鈕位置 (Operator Position)			型號 (Type No.)	使用電壓記號 (Operating Voltage Code)	顏色記號 (Lens Color Code)	
	記號 (Configuration)	位置 (Mounting)	類型 (Position)	L	R	---				
90°-2位置 / 交替型標準 旋鈕 (90°-2 Position / Knob Type with Maintained)	1NO (10)	1	NO		●		A20K-2AE10-2	無燈泡 (Without Lamp)	僅黑色 (Black Only)	
		2								
		3								
	1NC (01)	1								A20K-2AE01-2
		2								
		3	NC	●						
	2NO (20)	1	NO		●		A20K-2AE20-2			
		2								
		3	NO		●					
	2NC (02)	1	NC	●			A20K-2AE02-2			
		2								
		3	NC	●						
	1NO-1NC (11)	1	NO		●		A20K-2AE11-2			
		2								
		3	NC	●						
	3NO (30)	1	NO		●		A20K-2AE30-2			
		2	NO		●					
		3	NO		●					
3NC (03)	1	NC	●			A20K-2AE03-2				
	2	NC	●							
	3	NC	●							
2NO-1NC (21)	1	NO		●		A20K-2AE21-2				
	2	NO		●						
	3	NC	●							
1NO-2NC (12)	1	NO		●		A20K-2AE12-2				
	2	NC	●							
	3	NC	●							

■外型尺寸(Dimensions) mm

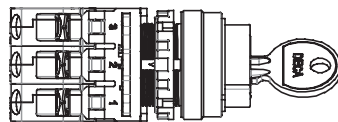

面板厚度 (Panel Thickness)
0.8~6

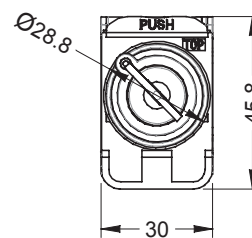
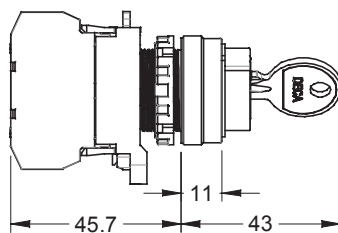

鑰匙選擇開關 (Key Selector Switches)

90° -2位置 / 右復歸型標準旋鈕 (90° -2 Position / Knob Type with Spring Return from Right)

A20K



位置數 (No. of Positions)	接點結構 (Contacts)			旋鈕位置 (Operator Position)			型號 (Type No.)	使用電壓記號 (Operating Voltage Code)	顏色記號 (Lens Color Code)	
	記號 (Configuration)	位置 (Mounting)	類型 (Position)	L	R	---				
90°-2位置 / 交替型標準 旋鈕 (90°-2 Position / Knob Type with Spring Return from Right)	1NO (10)	1	NO		●		A20K-21BE10-2	無燈泡 (Without Lamp)	僅黑色 (Black Only)	
		2								
		3								
	1NC (01)	1								A20K-21BE01-2
		2								
		3	NC	●						
	2NO (20)	1	NO			●				A20K-21BE20-2
		2								
		3	NO			●				
	2NC (02)	1	NC	●						A20K-21BE02-2
		2								
		3	NC	●						
	1NO-1NC (11)	1	NO			●				A20K-21BE11-2
		2								
		3	NC	●						
	3NO (30)	1	NO			●				A20K-21BE30-2
		2	NO			●				
		3	NO			●				
	3NC (03)	1	NC	●						A20K-21BE03-2
		2	NC	●						
		3	NC	●						
2NO-1NC (21)	1	NO			●		A20K-21BE21-2			
	2	NO			●					
	3	NC	●							
1NO-2NC (12)	1	NO			●		A20K-21BE12-2			
	2	NC	●							
	3	NC	●							

■外型尺寸(Dimensions) mm

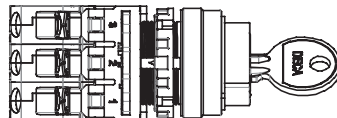

面板厚度 (Panel Thickness)
0.8~6

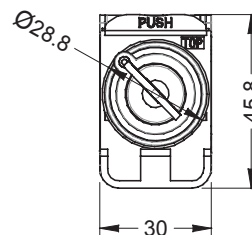
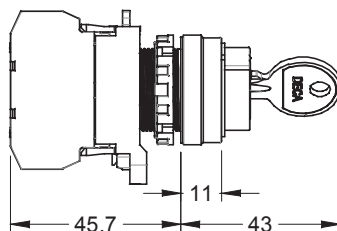

鑰匙選擇開關 (Key Selector Switches)

45° -3位置 / 交替型標準旋鈕 (45° -3 Position / Knob Type with Maintained)



A20K

位置數 (No. of Positions)	接點結構 (Contacts)			旋鈕位置 (Operator Position)			型號 (Type No.)	使用電壓記號 (Operating Voltage Code)	顏色記號 (Lens Color Code)	
	記號 (Configuration)	位置 (Mounting)	類型 (Position)	L	C	R				
45°-3位置 / 交替型標準 旋鈕 (45°-3 Position / Knob Type with Maintained) L C R	2NO (20)	1	NO	●			A20K-3AE20-2	無燈泡 (Without Lamp)	僅黑色 (Black Only)	
		2								
		3	NO			●				
	2NO (20N1)	1					●			A20K-3AE20N1-2
		2	NO	●		●				
		3	NO			●				
	2NC (02)	1	NC	—						A20K-3AE02-2
		2								
		3	NC	—						
	2NC (02N1)	1					●			A20K-3AE02N1-2
		2	NC	—						
		3	NC	—						
	1NO-1NC (11)	1	NO	●						A20K-3AE11-2
		2								
		3	NC	—						
	1NO-1NC (11N1)	1	NC	—						A20K-3AE11N1-2
		2								
		3	NO			●				
	1NO-1NC (11N2)	1	NO	●						A20K-3AE11N2-2
		2	NC		●					
3										
1NO-1NC (11N3)	1	NC	—				A20K-3AE11N3-2			
	2	NC	—	●						
	3	NO			●					
1NO-1NC (11N4)	1	NO	●				A20K-3AE11N4-2			
	2	NC	—							
	3	NC	—							
3NO (30)	1	NO	●			●	A20K-3AE30-2			
	2	NO	●			●				
	3	NO				●				
3NC (03)	1	NC	—				A20K-3AE03-2			
	2	NC	—	●						
	3	NC	—							
2NO-1NC (21)	1	NO	●				A20K-3AE21-2			
	2	NO	●			●				
	3	NC	—							
1NO-2NC (12)	1	NO	●				A20K-3AE12-2			
	2	NC		●						
	3	NC	—							

■外型尺寸(Dimensions) mm

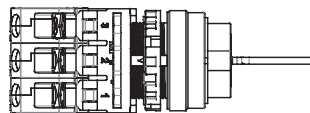

面板厚度 (Panel Thickness)
0.8~6

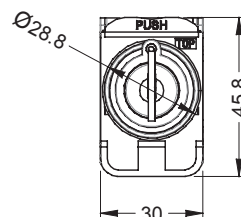
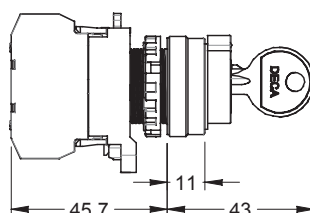

鑰匙選擇開關 (Key Selector Switches)

45° -3位置 / 右復歸型標準旋鈕 (45° -3 Position / Knob Type with Spring Return from Right)

A20K



位置數 (No. of Positions)	接點結構 (Contacts)			旋鈕位置 (Operator Position)			型號 (Type No.)	使用電壓記號 (Operating Voltage Code)	顏色記號 (Lens Color Code)	
	記號 (Configuration)	位置 (Mounting)	類型 (Position)	L	C	R				
45°-3位置 / 交替型標準 旋鈕 (45°-3 Position / Knob Type with Spring Return from Right)	2NO (20)	1	NO	●			A20K-31BE20-2	無燈泡 (Without Lamp)	僅黑色 (Black Only)	
		2								
		3	NO			●				
	2NO (20N1)	1					●			A20K-31BE20N1-2
		2	NO	●		●				
		3	NO			●	●			
	2NC (02)	1	NC		—					A20K-31BE02-2
		2								
		3	NC		—					
	2NC (02N1)	1				●				A20K-31BE02N1-2
		2	NC							
		3	NC		—					
	1NO-1NC (11)	1	NO	●						A20K-31BE11-2
		2								
		3	NC		—					
	1NO-1NC (11N1)	1	NC			—				A20K-31BE11N1-2
		2								
		3	NO				●			
	1NO-1NC (11N2)	1	NO	●						A20K-31BE11N2-2
		2	NC		●					
3										
1NO-1NC (11N3)	1						A20K-31BE11N3-2			
	2	NC		●						
	3	NO				●				
1NO-1NC (11N4)	1	NO	●			●	A20K-31BE11N4-2			
	2									
	3	NC		—						
3NO (30)	1	NO	●				A20K-31BE30-2			
	2	NO	●			●				
	3	NO				●				
3NC (03)	1	NC				—	A20K-31BE03-2			
	2	NC		●						
	3	NC		—						
2NO-1NC (21)	1	NO	●				A20K-31BE21-2			
	2	NO	●			●				
	3	NC		—						
1NO-2NC (12)	1	NO	●				A20K-31BE12-2			
	2	NC			●					
	3	NC		—						

■外型尺寸(Dimensions) mm

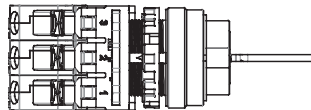

面板厚度 (Panel Thickness)
0.8~6

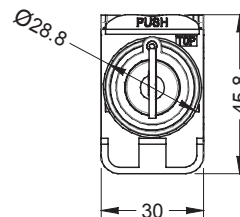
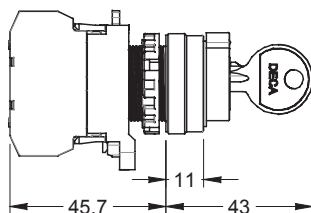

鑰匙選擇開關 (Key Selector Switches)

45° -3位置 / 左復歸型標準旋鈕 (45° -3 Position / Knob Type with Spring Return from Left)



A20K

位置數 (No. of Positions)	接點結構 (Contacts)			旋鈕位置 (Operator Position)			型號 (Type No.)	使用電壓記號 (Operating Voltage Code)	顏色記號 (Lens Color Code)	
	記號 (Configuration)	位置 (Mounting)	類型 (Position)	L	C	R				
45°-3位置 / 交替型標準 旋鈕 (45°-3 Position / Knob Type with Spring Return from Left)	2NO (20)	1	NO	●			A20K-32CE20-2	無燈泡 (Without Lamp)	僅黑色 (Black Only)	
		2								
		3	NO			●				
	2NO (20N1)	1					●			A20K-32CE20N1-2
		2	NO	●		●				
		3	NO			●				
	2NC (02)	1	NC		—					A20K-32CE02-2
		2								
		3	NC		—					
	2NC (02N1)	1					●			A20K-32CE02N1-2
		2	NC			●				
		3	NC		—					
	1NO-1NC (11)	1	NO	●						A20K-32CE11-2
		2								
		3	NC		—					
	1NO-1NC (11N1)	1	NC				—			A20K-32CE11N1-2
		2								
		3	NO				●			
	1NO-1NC (11N2)	1	NO	●						A20K-32CE11N2-2
		2	NC			●				
3										
1NO-1NC (11N3)	1						A20K-32CE11N3-2			
	2	NC			●					
	3	NO				●				
1NO-1NC (11N4)	1	NO	●			●	A20K-32CE11N4-2			
	2									
	3	NC		—						
3NO (30)	1	NO	●			●	A20K-32CE30-2			
	2	NO	●			●				
	3	NO	●			●				
3NC (03)	1	NC				—	A20K-32CE03-2			
	2	NC			●					
	3	NC		—						
2NO-1NC (21)	1	NO	●				A20K-32CE21-2			
	2	NO	●			●				
	3	NC		—						
1NO-2NC (12)	1	NO	●				A20K-32CE12-2			
	2	NC			●					
	3	NC		—						

■外型尺寸(Dimensions) mm

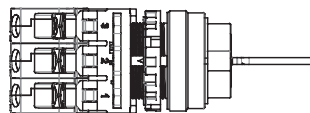

面板厚度 (Panel Thickness)
0.8~6

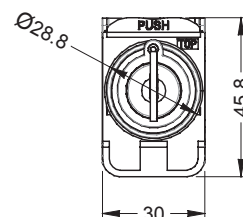
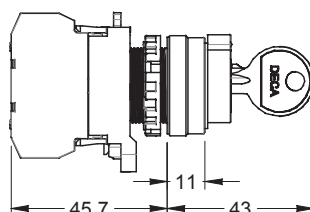

鑰匙選擇開關 (Key Selector Switches)

45° -3位置 / 雙向復歸型標準旋鈕 (45° -3 Position / Knob Type with Spring Return from Tow-Way)

A20K



位置數 (No. of Positions)	接點結構 (Contacts)			旋鈕位置 (Operator Position)			型號 (Type No.)	使用電壓記號 (Operating Voltage Code)	顏色記號 (Lens Color Code)	
	記號 (Configuration)	位置 (Mounting)	類型 (Position)	L	C	R				
45°-3位置 / 交替型標準 旋鈕 (45°-3 Position / Knob Type with Spring Return from Tow- Way)	2NO (20)	1	NO	●			A20K-33DE20-2	無燈泡 (Without Lamp)	僅黑色 (Black Only)	
		2								
		3	NO			●				
	2NO (20N1)	1					●			A20K-33DE20N1-2
		2	NO	●		●				
		3	NO			●	●			
	2NC (02)	1	NC		—					A20K-33DE02-2
		2								
		3	NC		—					
	2NC (02N1)	1				●				A20K-33DE02N1-2
		2	NC							
		3	NC		—					
	1NO-1NC (11)	1	NO	●						A20K-33DE11-2
		2								
		3	NC		—					
	1NO-1NC (11N1)	1	NC			—				A20K-33DE11N1-2
		2								
		3	NO				●			
	1NO-1NC (11N2)	1	NO	●						A20K-33DE11N2-2
		2	NC		●					
3										
1NO-1NC (11N3)	1						A20K-33DE11N3-2			
	2	NC		●						
	3	NO				●				
1NO-1NC (11N4)	1						A20K-33DE11N4-2			
	2	NO	●		●					
	3	NC		—						
3NO (30)	1	NO	●			●	A20K-33DE30-2			
	2	NO	●			●				
	3	NO	●			●				
3NC (03)	1	NC				—	A20K-33DE03-2			
	2	NC		●						
	3	NC		—						
2NO-1NC (21)	1	NO	●				A20K-33DE21-2			
	2	NO	●			●				
	3	NC		—						
1NO-2NC (12)	1	NO	●				A20K-33DE12-2			
	2	NC			●					
	3	NC		—						

■外型尺寸(Dimensions) mm

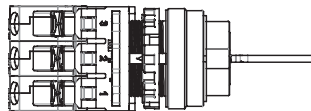

面板厚度 (Panel Thickness)
0.8~6

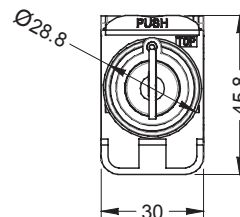
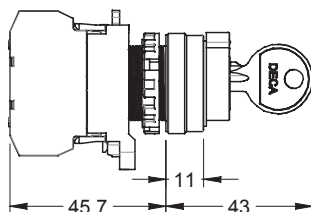

開關構造說明 (Switch Construction Instructions)

鑰匙選擇開關 (Key Selector Switches)

A204K

鑰匙選擇開關操作部
(Key Selector Switches
Operators)
Page.129

鑰匙選擇開關
(Key Selector Switches)
Page.107-119



開關接點部
(Contact Block
Assemblies)
Page.137-140



接點塊安裝轉接器
(Contact Block
Mounting Adapter)
Page.140



接點塊
(Contact Block)
Page.139



接點塊
(Contact Block)
Page.139



接點塊
(Contact Block)
Page.139

Ø22 A20 系列控制元件 (Metal Bezels)

鑰匙選擇開關 (Key Selector Switches)

90° -2位置 / 交替型金屬框標準旋鈕 (90° -2 Position / Knob Type with Maintained & Metal Bezel)

A204K



位置數 (No. of Positions)	接點結構 (Contacts)			旋鈕位置 (Operator Position)			型號 (Type No.)	使用電壓記號 (Operating Voltage Code)	顏色記號 (Lens Color Code)	
	記號 (Configuration)	位置 (Mounting)	類型 (Position)	L	R	---				
90°-2位置 / 交替型標準 旋鈕 (90°-2 Position / Knob Type with Maintained)	1NO (10)	1	NO		●		A204K-2AE10-2	無燈泡 (Without Lamp)	僅黑色 (Black Only)	
		2								
		3								
	1NC (01)	1								A204K-2AE01-2
		2								
		3	NC	●						
	2NO (20)	1	NO			●				A204K-2AE20-2
		2								
		3	NO			●				
	2NC (02)	1	NC	●						A204K-2AE02-2
		2								
		3	NC	●						
1NO-1NC (11)	1	NO			●		A204K-2AE11-2			
	2									
	3	NC	●							
3NO (30)	1	NO			●		A204K-2AE30-2			
	2	NO			●					
	3	NO			●					
3NC (03)	1	NC	●				A204K-2AE03-2			
	2	NC	●							
	3	NC	●							
2NO-1NC (21)	1	NO			●		A204K-2AE21-2			
	2	NO			●					
	3	NC	●							
1NO-2NC (12)	1	NO			●		A204K-2AE12-2			
	2	NC	●							
	3	NC	●							

■外型尺寸(Dimensions) mm

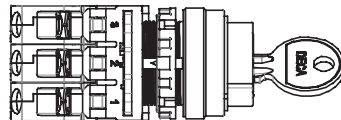

面板厚度 (Panel Thickness)
0.8~6

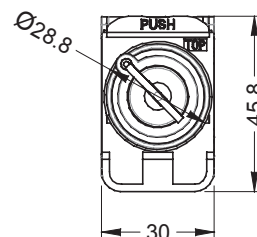
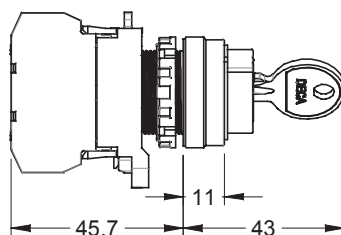

鑰匙選擇開關 (Key Selector Switches)

90° -2位置 / 交替型金屬框標準旋鈕 (90° -2 Position / Knob Type with Maintained & Metal Silhouette)



A204K

位置數 (No. of Positions)	接點結構 (Contacts)			旋鈕位置 (Operator Position)			型號 (Type No.)	使用電壓記號 (Operating Voltage Code)	顏色記號 (Lens Color Code)	
	記號 (Configuration)	位置 (Mounting)	類型 (Position)	L	R	---				
90°-2位置 / 交替型標準 旋鈕 (90°-2 Position / Knob Type with Maintained)	1NO (10)	1	NO		●		A204K-2AE10-2U	無燈泡 (Without Lamp)	僅黑色 (Black Only)	
		2								
		3								
	1NC (01)	1								A204K-2AE01-2U
		2								
		3	NC	●						
	2NO (20)	1	NO			●				A204K-2AE20-2U
		2								
		3	NO			●				
	2NC (02)	1	NC	●						A204K-2AE02-2U
		2								
		3	NC	●						
1NO-1NC (11)	1	NO			●		A204K-2AE11-2U			
	2									
	3	NC	●							
3NO (30)	1	NO			●		A204K-2AE30-2U			
	2	NO			●					
	3	NO			●					
3NC (03)	1	NC	●				A204K-2AE03-2U			
	2	NC	●							
	3	NC	●							
2NO-1NC (21)	1	NO			●		A204K-2AE21-2U			
	2	NO			●					
	3	NC	●							
1NO-2NC (12)	1	NO			●		A204K-2AE12-2U			
	2	NC	●							
	3	NC	●							

■外型尺寸(Dimensions) mm

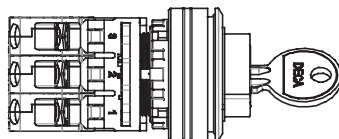

面板厚度 (Panel Thickness)
0.8~6

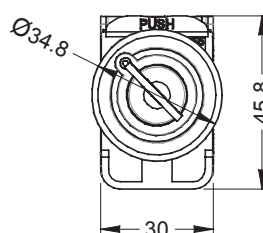
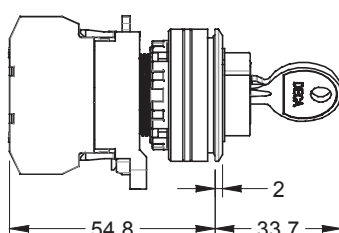

鑰匙選擇開關 (Key Selector Switches)

90° -2位置 / 右復歸型金屬框標準旋鈕 (90° -2 Position / Knob Type with Spring Return from Right & Metal Bezel)

A204K



位置數 (No. of Positions)	接點結構 (Contacts)			旋鈕位置 (Operator Position)			型號 (Type No.)	使用電壓記號 (Operating Voltage Code)	顏色記號 (Lens Color Code)	
	記號 (Configuration)	位置 (Mounting)	類型 (Position)	L	R	---				
90°-2位置 / 交替型標準 旋鈕 (90°-2 Position / Knob Type with Spring Return from Right)	1NO (10)	1	NO		●		A204K-21BE10-2	無燈泡 (Without Lamp)	僅黑色 (Black Only)	
		2								
		3								
	1NC (01)	1								A204K-21BE01-2
		2								
		3	NC	●						
	2NO (20)	1	NO			●	A204K-21BE20-2			
		2								
		3	NO			●				
	2NC (02)	1	NC	●			A204K-21BE02-2			
		2								
		3	NC	●						
1NO-1NC (11)	1	NO			●	A204K-21BE11-2				
	2									
	3	NC	●							
3NO (30)	1	NO			●	A204K-21BE30-2				
	2	NO			●					
	3	NO			●					
3NC (03)	1	NC	●			A204K-21BE03-2				
	2	NC	●							
	3	NC	●							
2NO-1NC (21)	1	NO			●	A204K-21BE21-2				
	2	NO			●					
	3	NC	●							
1NO-2NC (12)	1	NO			●	A204K-21BE12-2				
	2	NC	●							
	3	NC	●							

■外型尺寸(Dimensions) mm

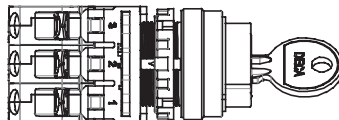

面板厚度 (Panel Thickness)
0.8~6

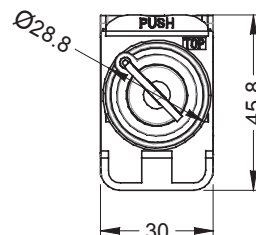
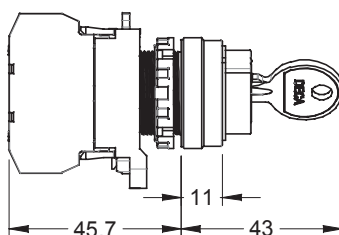

鑰匙選擇開關 (Key Selector Switches)

90° -2位置 / 右復歸型金屬框標準旋鈕 (90° -2 Position / Knob Type with Spring Return from Right & Metal Silhouette)



A204K

位置數 (No. of Positions)	接點結構 (Contacts)			旋鈕位置 (Operator Position)			型號 (Type No.)	使用電壓記號 (Operating Voltage Code)	顏色記號 (Lens Color Code)	
	記號 (Configuration)	位置 (Mounting)	類型 (Position)	L	R	---				
90°-2位置 / 交替型標準 旋鈕 (90°-2 Position / Knob Type with Spring Return from Right)	1NO (10)	1	NO		●		A204K-21BE10-2U	無燈泡 (Without Lamp)	僅黑色 (Black Only)	
		2								
		3								
	1NC (01)	1								A204K-21BE01-2U
		2								
		3	NC	●						
	2NO (20)	1	NO			●				A204K-21BE20-2U
		2								
		3	NO			●				
	2NC (02)	1	NC	●						A204K-21BE02-2U
		2								
		3	NC	●						
1NO-1NC (11)	1	NO			●		A204K-21BE11-2U			
	2									
	3	NC	●							
3NO (30)	1	NO			●		A204K-21BE30-2U			
	2	NO			●					
	3	NO			●					
3NC (03)	1	NC	●				A204K-21BE03-2U			
	2	NC	●							
	3	NC	●							
2NO-1NC (21)	1	NO			●		A204K-21BE21-2U			
	2	NO			●					
	3	NC	●							
1NO-2NC (12)	1	NO			●		A204K-21BE12-2U			
	2	NC	●							
	3	NC	●							

■外型尺寸(Dimensions) mm

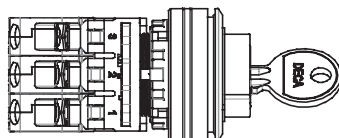

面板厚度 (Panel Thickness)
0.8~6

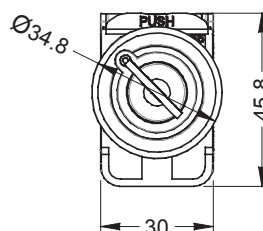
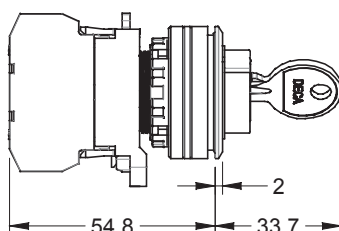

Ø22 A20 系列控制元件 (Metal Bezels)

鑰匙選擇開關 (Key Selector Switches)

45° -3位置 / 交替型金屬框標準旋鈕 (45° -3 Position / Knob Type with Maintained & Metal Bezel)

A204K



位置數 (No. of Positions)	接點結構 (Contacts)			旋鈕位置 (Operator Position)			型號 (Type No.)	使用電壓記號 (Operating Voltage Code)	顏色記號② (Lens Color Code②)
	記號 (Configuration)	位置 (Mounting)	類型 (Position)	L	C	R			
45°-3位置 / 交替型標準 旋鈕 (45°-3 Position / Knob Type with Maintained)	2NO (20)	1	NO	●			A204K-3AE20-2	無燈泡 (Without Lamp)	僅黑色 (Black Only)
		2	NO			●			
	2NO (20N1)	1	NO	●		●	A204K-3AE20N1-2		
		3	NO			●			
	2NC (02)	1	NC		—		A204K-3AE02-2		
		3	NC		—				
	2NC (02N1)	1	NC			●	A204K-3AE02N1-2		
		3	NC		—				
	1NO-1NC (11)	1	NO	●			A204K-3AE11-2		
		3	NC		—				
	1NO-1NC (11N1)	1	NC			—	A204K-3AE11N1-2		
		3	NO			●			
	1NO-1NC (11N2)	1	NO	●			A204K-3AE11N2-2		
		3	NC		●				
	1NO-1NC (11N3)	1	NO			●	A204K-3AE11N3-2		
		3	NO			●			
	1NO-1NC (11N4)	1	NO	●		●	A204K-3AE11N4-2		
		3	NC		—				
	3NO (30)	1	NO	●			A204K-3AE30-2		
		3	NO	●		●			
3NC (03)	1	NC			—	A204K-3AE03-2			
	3	NC		—					
2NO-1NC (21)	1	NO	●			A204K-3AE21-2			
	3	NC		—	●				
1NO-2NC (12)	1	NO	●			A204K-3AE12-2			
	3	NC		—	●				

■外型尺寸(Dimensions) mm

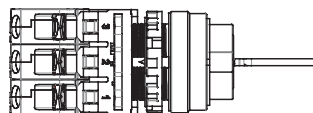

面板厚度 (Panel Thickness)
0.8~6

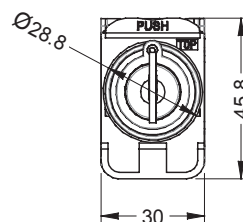
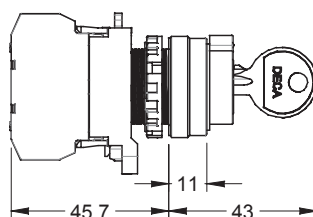

鑰匙選擇開關 (Key Selector Switches)

45° -3位置 / 交替型金屬框標準旋鈕 (45° -3 Position / Knob Type with Maintained & Metal Silhouette)



A204K

位置數 (No. of Positions)	接點結構 (Contacts)			旋鈕位置 (Operator Position)			型號 (Type No.)	使用電壓記號 (Operating Voltage Code)	顏色記號 (Lens Color Code)
	記號 (Configuration)	位置 (Mounting)	類型 (Position)	L	C	R			
45°-3位置 / 交替型標準 旋鈕 (45°-3 Position / Knob Type with Maintained) L C R	2NO (20)	1	NO	●			A204K-3AE20-2U	無燈泡 (Without Lamp)	僅黑色 (Black Only)
		2	NO			●			
	2NO (20N1)	1	NO	●		●	A204K-3AE20N1-2U		
		3	NO			●			
	2NC (02)	1	NC		—		A204K-3AE02-2U		
		2	NC		—				
	2NC (02N1)	1	NC			●	A204K-3AE02N1-2U		
		3	NC		—				
	1NO-1NC (11)	1	NO	●			A204K-3AE11-2U		
		3	NC		—				
	1NO-1NC (11N1)	1	NC			●	A204K-3AE11N1-2U		
		3	NO			●			
	1NO-1NC (11N2)	1	NO	●			A204K-3AE11N2-2U		
		3	NC		●				
	1NO-1NC (11N3)	1	NO			●	A204K-3AE11N3-2U		
		3	NO			●			
	1NO-1NC (11N4)	1	NO	●		●	A204K-3AE11N4-2U		
		3	NC		—				
	3NO (30)	1	NO	●		●	A204K-3AE30-2U		
		3	NO	●		●			
3NC (03)	1	NC		—		A204K-3AE03-2U			
	3	NC		●					
2NO-1NC (21)	1	NO	●		●	A204K-3AE21-2U			
	3	NC		—					
1NO-2NC (12)	1	NO	●			A204K-3AE12-2U			
	2	NC		●					
		3	NC		—				

■外型尺寸(Dimensions) mm

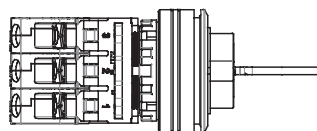

面板厚度 (Panel Thickness)
0.8~6

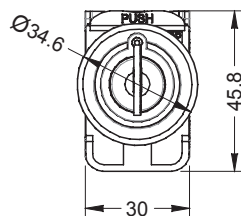
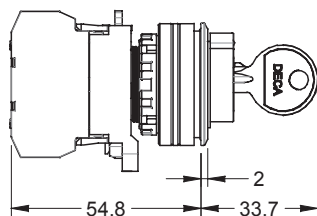

鑰匙選擇開關 (Key Selector Switches)

45° -3位置 / 右復歸型金屬框標準旋鈕 (45° -3 Position / Knob Type with Spring Return from Right & Metal Bezel)

A204K



位置數 (No. of Positions)	接點結構 (Contacts)			旋鈕位置 (Operator Position)			型號 (Type No.)	使用電壓記號 (Operating Voltage Code)	顏色記號 (Lens Color Code)	
	記號 (Configuration)	位置 (Mounting)	類型 (Position)	L	C	R				
45°-3位置 / 交替型標準 旋鈕 (45°-3 Position / Knob Type with Spring Return from Right)	2NO (20)	1	NO	●			A204K-31BE20-2	無燈泡 (Without Lamp)	僅黑色 (Black Only)	
		2								
		3	NO			●				
	2NO (20N1)	1			●		●			A204K-31BE20N1-2
		2	NO		●		●			
		3	NO				●			
	2NC (02)	1		NC		—				A204K-31BE02-2
		2								
		3	NC		—					
	2NC (02N1)	1					●			A204K-31BE02N1-2
		2	NC		—					
		3	NC		—					
	1NO-1NC (11)	1		NO	●					A204K-31BE11-2
		2								
		3	NC		—					
	1NO-1NC (11N1)	1		NC			—			A204K-31BE11N1-2
		2								
		3	NO				●			
	1NO-1NC (11N2)	1		NO	●					A204K-31BE11N2-2
		2		NC		●				
3										
1NO-1NC (11N3)	1				●		A204K-31BE11N3-2			
	2	NC								
	3	NO				●				
1NO-1NC (11N4)	1		NO	●		●	A204K-31BE11N4-2			
	2		NC		—					
	3									
3NO (30)	1		NO	●		●	A204K-31BE30-2			
	2		NO	●		●				
	3		NO	●		●				
3NC (03)	1		NC			—	A204K-31BE03-2			
	2		NC		●					
	3		NC		—					
2NO-1NC (21)	1		NO	●		●	A204K-31BE21-2			
	2		NO	●		●				
	3		NC		—					
1NO-2NC (12)	1		NO	●			A204K-31BE12-2			
	2		NC		●					
	3		NC		—					

■ 外型尺寸 (Dimensions) mm

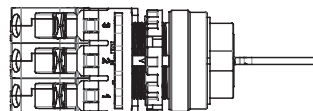

面板厚度 (Panel Thickness)
0.8~6

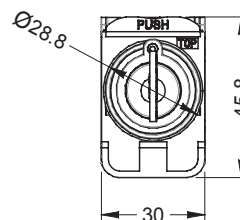
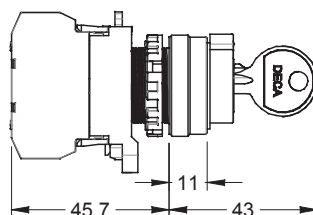

鑰匙選擇開關 (Key Selector Switches)

45° -3位置 / 右復歸型金屬框標準旋鈕 (45° -3 Position / Knob Type with Spring Return from Right & Metal Silhouette)



A204K

位置數 (No. of Positions)	接點結構 (Contacts)			旋鈕位置 (Operator Position)			型號 (Type No.)	使用電壓記號 (Operating Voltage Code)	顏色記號 (Lens Color Code)	
	記號 (Configuration)	位置 (Mounting)	類型 (Position)	L	C	R				
45°-3位置 / 交替型標準 旋鈕 (45°-3 Position / Knob Type with Spring Return from Right)	2NO (20)	1	NO	●			A204K-31BE20-2U	無燈泡 (Without Lamp)	僅黑色 (Black Only)	
		2								
		3	NO			●				
	2NO (20N1)	1					●			A204K-31BE20N1-2U
		2	NO	●		●				
		3	NO			●	●			
	2NC (02)	1	NC			—				A204K-31BE02-2U
		2								
		3	NC		—					
	2NC (02N1)	1								A204K-31BE02N1-2U
		2	NC			●				
		3	NC		—					
	1NO-1NC (11)	1	NO	●						A204K-31BE11-2U
		2								
		3	NC		—					
	1NO-1NC (11N1)	1	NC			—				A204K-31BE11N1-2U
		2								
		3	NO				●			
	1NO-1NC (11N2)	1	NO	●						A204K-31BE11N2-2U
		2	NC			●				
3										
1NO-1NC (11N3)	1						A204K-31BE11N3-2U			
	2	NC			●					
	3	NO				●				
1NO-1NC (11N4)	1						A204K-31BE11N4-2U			
	2	NO	●			●				
	3	NC		—						
3NO (30)	1	NO	●				A204K-31BE30-2U			
	2	NO	●			●				
	3	NO				●				
3NC (03)	1	NC			—		A204K-31BE03-2U			
	2	NC			●					
	3	NC		—						
2NO-1NC (21)	1	NO	●				A204K-31BE21-2U			
	2	NO	●			●				
	3	NC		—						
1NO-2NC (12)	1	NO	●				A204K-31BE12-2U			
	2	NC			●					
	3	NC		—						

■外型尺寸(Dimensions) mm

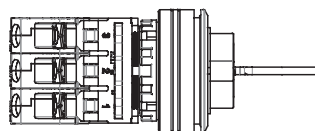

面板厚度 (Panel Thickness)
0.8~6

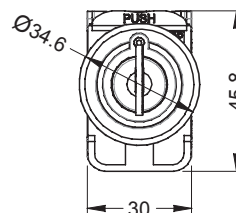
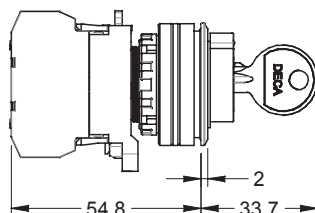

鑰匙選擇開關 (Key Selector Switches)

45° -3位置 / 左復歸型金屬框標準旋鈕 (45° -3 Position / Knob Type with Spring Return from Left & Metal Bezel)

A204K



位置數 (No. of Positions)	接點結構 (Contacts)			旋鈕位置 (Operator Position)			型號 (Type No.)	使用電壓記號 (Operating Voltage Code)	顏色記號 (Lens Color Code)	
	記號 (Configuration)	位置 (Mounting)	類型 (Position)	L	C	R				
45°-3位置 / 交替型標準 旋鈕 (45°-3 Position / Knob Type with Spring Return from Left)	2NO (20)	1	NO	●			A204K-32CE20-2	無燈泡 (Without Lamp)	僅黑色 (Black Only)	
		2								
		3	NO			●				
	2NO (20N1)	1			●		●			A204K-32CE20N1-2
		2	NO		●		●			
		3	NO				●			
	2NC (02)	1	NC			—				A204K-32CE02-2
		2								
		3	NC		—					
	2NC (02N1)	1					●			A204K-32CE02N1-2
		2	NC							
		3	NC		—					
	1NO-1NC (11)	1	NO		●					A204K-32CE11-2
		2								
		3	NC		—					
	1NO-1NC (11N1)	1	NC				—			A204K-32CE11N1-2
		2								
		3	NO				●			
	1NO-1NC (11N2)	1	NO		●					A204K-32CE11N2-2
		2	NC			●				
3										
1NO-1NC (11N3)	1					●	A204K-32CE11N3-2			
	2	NC			●					
	3	NO				●				
1NO-1NC (11N4)	1	NO		●		●	A204K-32CE11N4-2			
	2	NC			—					
	3	NC		—						
3NO (30)	1	NO		●		●	A204K-32CE30-2			
	2	NO		●		●				
	3	NO		●		●				
3NC (03)	1	NC				—	A204K-32CE03-2			
	2	NC			●					
	3	NC		—						
2NO-1NC (21)	1	NO		●		●	A204K-32CE21-2			
	2	NO		●		●				
	3	NC		—						
1NO-2NC (12)	1	NO		●			A204K-32CE12-2			
	2	NC			●					
	3	NC		—						

■ 外型尺寸(Dimensions) mm

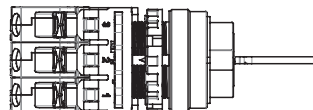

面板厚度 (Panel Thickness)
0.8~6

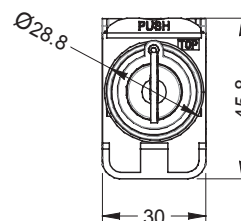
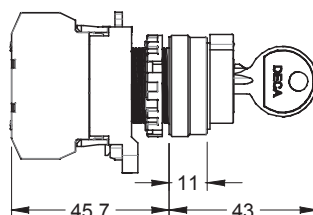

鑰匙選擇開關 (Key Selector Switches)

45° -3位置 / 左復歸型金屬框標準旋鈕 (45° -3 Position / Knob Type with Spring Return from Left & Metal Silhouette)



A204K

位置數 (No. of Positions)	接點結構 (Contacts)			旋鈕位置 (Operator Position)			型號 (Type No.)	使用電壓記號 (Operating Voltage Code)	顏色記號 (Lens Color Code)	
	記號 (Configuration)	位置 (Mounting)	類型 (Position)	L	C	R				
45°-3位置 / 交替型標準 旋鈕 (45°-3 Position / Knob Type with Spring Return from Left)	2NO (20)	1	NO	●			A204K-32CE20-2U	無燈泡 (Without Lamp)	僅黑色 (Black Only)	
		2								
		3	NO			●				
	2NO (20N1)	1					●			A204K-32CE20N1-2U
		2	NO	●		●				
		3	NO			●				
	2NC (02)	1	NC		——					A204K-32CE02-2U
		2								
		3	NC		——					
	2NC (02N1)	1					●			A204K-32CE02N1-2U
		2	NC		——					
		3	NC		——					
	1NO-1NC (11)	1	NO	●						A204K-32CE11-2U
		2								
		3	NC		——					
	1NO-1NC (11N1)	1	NC				●			A204K-32CE11N1-2U
		2								
		3	NO				●			
	1NO-1NC (11N2)	1	NO	●						A204K-32CE11N2-2U
		2	NC		●					
		3								
1NO-1NC (11N3)	1					●	A204K-32CE11N3-2U			
	2	NC		●						
	3	NO				●				
1NO-1NC (11N4)	1	NO	●			●	A204K-32CE11N4-2U			
	2	NC		——						
	3	NC		——						
3NO (30)	1	NO	●			●	A204K-32CE30-2U			
	2	NO	●			●				
	3	NO				●				
3NC (03)	1	NC		——			A204K-32CE03-2U			
	2	NC		●						
	3	NC		——						
2NO-1NC (21)	1	NO	●			●	A204K-32CE21-2U			
	2	NO	●							
	3	NC		——						
1NO-2NC (12)	1	NO	●				A204K-32CE12-2U			
	2	NC		●						
	3	NC		——						

■外型尺寸(Dimensions) mm

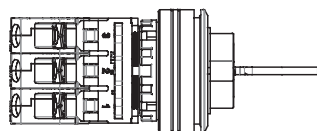

面板厚度 (Panel Thickness)
0.8~6

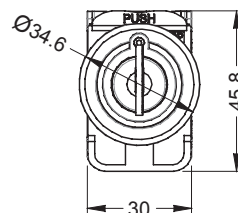
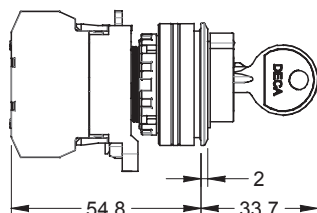

Ø22 A20 系列控制元件 (Metal Bezels)

鑰匙選擇開關 (Key Selector Switches)

45° -3位置 / 雙向復歸型金屬框標準旋鈕 (45° -3 Position / Knob Type with Spring Return from Tow-Way & Metal Bezel)

A204K



位置數 (No. of Positions)	接點結構 (Contacts)			旋鈕位置 (Operator Position)			型號 (Type No.)	使用電壓記號 (Operating Voltage Code)	顏色記號 (Lens Color Code)	
	記號 (Configuration)	位置 (Mounting)	類型 (Position)	L	C	R				
45°-3位置 / 交替型標準 旋鈕 (45°-3 Position / Knob Type with Spring Return from Tow- Way) L C R	2NO (20)	1	NO	●			A204K-33DE20-2	無燈泡 (Without Lamp)	僅黑色 (Black Only)	
		2								
	2NO (20N1)	1					●			A204K-33DE20N1-2
		2	NO	●						
	2NC (02)	1		NC		—				A204K-33DE02-2
		2								
	2NC (02N1)	1					●			A204K-33DE02N1-2
		2	NC	—						
	1NO-1NC (11)	1		NO	●					A204K-33DE11-2
		2		NC		—				
	1NO-1NC (11N1)	1		NO			●			A204K-33DE11N1-2
		2		NC		—				
	1NO-1NC (11N2)	1		NO	●					A204K-33DE11N2-2
		2		NC		●				
	1NO-1NC (11N3)	1		NO			●			A204K-33DE11N3-2
		2		NC		●				
	1NO-1NC (11N4)	1		NO	●		●			A204K-33DE11N4-2
		2		NC		—				
	3NO (30)	1		NO	●		●			A204K-33DE30-2
		2		NO	●		●			
3NC (03)	1		NC		—		A204K-33DE03-2			
	2		NC		●					
2NO-1NC (21)	1		NO	●		●	A204K-33DE21-2			
	2		NO	●						
1NO-2NC (12)	1		NO	●			A204K-33DE12-2			
	2		NC		●					
		3	NC		—					

■外型尺寸(Dimensions) mm

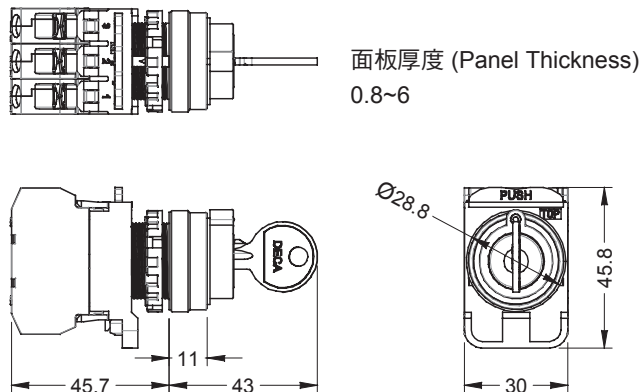

鑰匙選擇開關 (Key Selector Switches)

45° -3位置 / 雙向復歸型金屬框標準旋鈕 (45° -3 Position / Knob Type with Spring Return from Tow-Way & Metal Silhouette)



A204K

位置數 (No. of Positions)	接點結構 (Contacts)			旋鈕位置 (Operator Position)			型號 (Type No.)	使用電壓記號 (Operating Voltage Code)	顏色記號 (Lens Color Code)		
	記號 (Configuration)	位置 (Mounting)	類型 (Position)	L	C	R					
45°-3位置 / 交替型標準 旋鈕 (45°-3 Position / Knob Type with Spring Return from Tow- Way)	2NO (20)	1	NO	●			A204K-33DE20-2U	無燈泡 (Without Lamp)	僅黑色 (Black Only)		
		2									
		3	NO			●					
	2NO (20N1)	1			●		●			A204K-33DE20N1-2U	
		2	NO				●				
		3	NO				●				
	2NC (02)	1	NC			——				A204K-33DE02-2U	
		2									
		3	NC		——						
	2NC (02N1)	1					●			A204K-33DE02N1-2U	
		2	NC								
		3	NC		——						
	1NO-1NC (11)	1	NO		●					A204K-33DE11-2U	
		2									
		3	NC		——						
	1NO-1NC (11N1)	1	NC				——			A204K-33DE11N1-2U	
		2									
		3	NO				●				
	1NO-1NC (11N2)	1	NO		●					A204K-33DE11N2-2U	
		2	NC			●					
3											
1NO-1NC (11N3)	1					●	A204K-33DE11N3-2U				
	2	NC			●						
	3	NO				●					
1NO-1NC (11N4)	1	NO		●		●	A204K-33DE11N4-2U				
	2	NO		●		●					
	3	NC		——							
3NO (30)	1	NO		●		●	A204K-33DE30-2U				
	2	NO		●		●					
	3	NO				●					
3NC (03)	1	NC				——		A204K-33DE03-2U			
	2	NC			●						
	3	NC		——							
2NO-1NC (21)	1	NO		●		●	A204K-33DE21-2U				
	2	NO		●		●					
	3	NC		——							
1NO-2NC (12)	1	NO		●			A204K-33DE12-2U				
	2	NC			●						
	3	NC		——							

■外型尺寸(Dimensions) mm

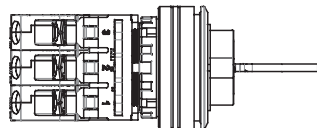

面板厚度 (Panel Thickness)
0.8~6

