

Features of Spring Clamp Terminal Blocks 彈片壓接型接線座

Features of Spring Clamp Terminal Blocks

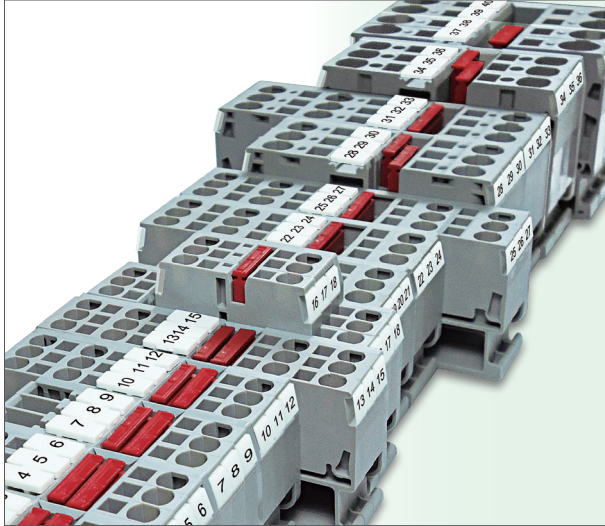

Features of Spring Clamp Terminal Blocks

- Space-saving design / Front connection.
- Vibration proof anti-loosening wire connection with pre-stressed Spring Clamp.
- Easy to operate, fast wiring installation with top wire entry.
- Easy mounting and dismounting from the terminal rail.
- Corrosion-proof terminal points.
- Low contact resistance.
- Easy for the extension of terminal connection.
- Easy handling and safe connection.

彈片壓接型接線座之特性

- 節省空間之特性 / 前緣導線連接方式
- 高強度壓力的彈度迫緊連接方式，具有抗震與防鬆的效果
- 操作簡便且快速的導線安裝方式（頂部進線）
- 抗腐蝕性佳（使用良好的金屬材料）
- 接線座從軌道上安裝及拆卸容易
- 低接觸電阻
- 容易擴充及延伸性佳
- 操作簡便且連接處安全性高

DST 1.5-D

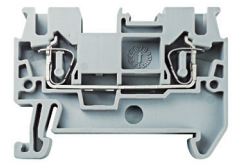

Specifications (產品規格)	1.5mm ²	
Technical Data (技術參數)	Rated voltage / Rated current / Wire Size	
UL	600V / 15A / AWG 28-14	
CSA	600V / 15A / AWG 28-14	
IEC	500V / 17.5A / 0.08-1.5mm ²	
Insulating impulse voltage withstand / Pollution degree (額定衝擊電壓 / 汙染等級)	6KV / 3	
Insulation stripping length (mm) (剝線長度)	10mm	
Material / Available Color (材質顏色)	● ● ● ● ●	
Rail Dimensions (導軌尺寸)	T / W / H (mm)	
For TS35x 7.5 	4.2 x 48.8 x 36.5	
For TS35x 15 	4.2 x 48.8 x 44	
Accessories (附件)	Cat. No.	Qty.
End Bracket (終端擋板) 	SEW35	50
End Plate (擋板) 	DD-ST2.5-D	50
Comb Link (邊接式聯接件) 	ODFBS2-4	50
	ODFBS3-4	50
	ODFBS4-4	50
	ODFBS5-4	50
	ODFBS10-4	10
Marking Tags (標記號) 	DUC-TMF4	10 (側面 120 位)
	DUC-TM4	10 (正面 120 位)
Tool (工具) 	DS2 (0.4 x 2.5mm)	

Features of Spring Clamp Terminal Blocks 彈片壓接型接線座

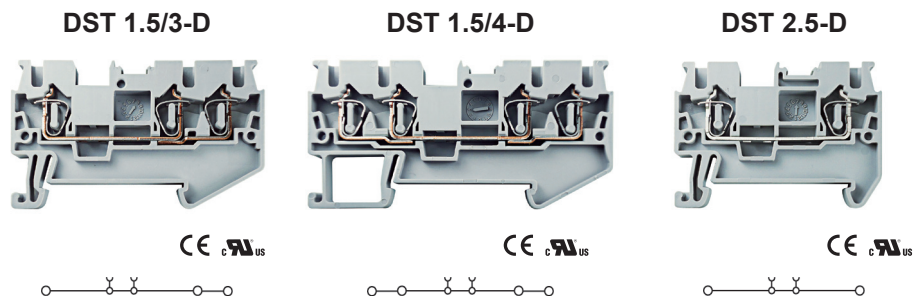

Specifications (產品規格)	1.5mm ²	1.5mm ²	2.5mm ²
Technical Data (技術參數)	Rated voltage / Rated current / Wire Size	Rated voltage / Rated current / Wire Size	Rated voltage / Rated current / Wire Size
UL	600V / 15A / AWG 28-14	600V / 15A / AWG 28-14	600V / 20A / AWG 28-12
CSA	600V / 15A / AWG 28-14	600V / 15A / AWG 28-14	600V / 20A / AWG 28-12
IEC	500V / 17.5A / 0.08-1.5mm ²	500V / 17.5A / 0.08-1.5mm ²	800V / 31A / 0.08-2.5mm ²
Insulating impulse voltage withstand / Pollution degree (額定衝擊電壓 / 污染等級)	6KV / 3	6KV / 3	8KV / 3
Insulation stripping length (mm) (剝線長度)	10mm	10mm	10mm
Material / Available Color (材質顏色)			
Rail Dimensions (導軌尺寸)	T / W / H (mm)	T / W / H (mm)	T / W / H (mm)
For TS35x 7.5	4.2 x 60.7 x 36.5	4.2 x 72.6 x 36.5	5.2 x 48.8 x 36.5
For TS35x 15	4.2 x 60.7 x 44	4.2 x 72.6x 44	5.2 x 48.8 x 44
Accessories (附件)	Cat. No. Qty.	Cat. No. Qty.	Cat. No. Qty.
End Bracket (終端擋板)	SEW35 50	SEW35 50	SEW35 50
End Plate (擋板)	DD-ST2.5/3-D 50	DD-ST2.5/4-D 50	DD-ST2.5-D 50
Comb Link (邊接式聯接件)	ODFBS2-4 50 ODFBS3-4 50 ODFBS4-4 50 ODFBS5-4 50 ODFBS10-4 10	ODFBS2-4 50 ODFBS3-4 50 ODFBS4-4 50 ODFBS5-4 50 ODFBS10-4 10	ODFBS2-5 50 ODFBS3-5 50 ODFBS4-5 50 ODFBS5-5 50 ODFBS10-5 10
Marking Tags (標記號)	DUC-TMF4 10 (側面 120 位) DUC-TM4 10 (正面 120 位)	DUC-TMF4 10 (側面 120 位) DUC-TM4 10 (正面 120 位)	DUC-TMF5 96 (側面 96 位) DUC-TM5 96 (正面 69 位)
Tool (工具)	DS2 (0.4 x 2.5mm)	DS2(0.4 x 2.5mm)	DS3(0.4 x 3.5mm)

Features of Spring Clamp Terminal Blocks 彈片壓接型接線座

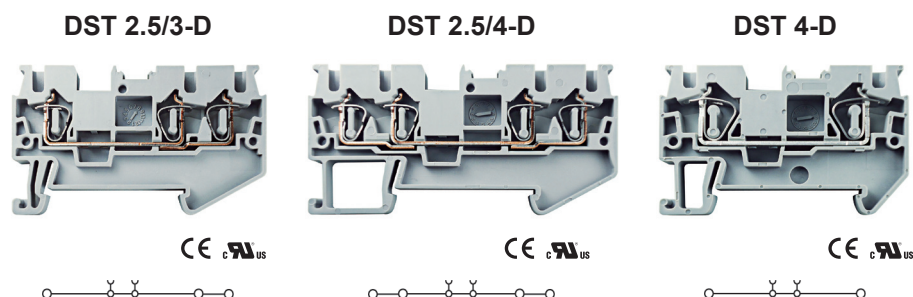

Specifications (產品規格)	2.5mm ²	2.5mm ²	4mm ²
Technical Data (技術參數)	Rated voltage / Rated current / Wire Size	Rated voltage / Rated current / Wire Size	Rated voltage / Rated current / Wire Size
UL	600V / 20A / AWG 28-12	600V / 20A / AWG 28-12	600V / 30A / AWG 28-10
CSA	600V / 20A / AWG 28-12	600V / 20A / AWG 28-12	600V / 30A / AWG 28-10
IEC	800V / 28A / 0.08-2.5mm ²	800V / 28A / 0.08-2.5mm ²	800V / 40A / 0.08-4mm ²
Insulating Impulse voltage withstand / Pollution degree (額定衝擊電壓 / 汙染等級)	8KV / 3	8KV / 3	8KV / 3
Insulation stripping length (mm) (剝線長度)	10mm	10mm	10mm
Material / Available Color (材質顏色)			
Rail Dimensions (導軌尺寸)	T / W / H (mm)	T / W / H (mm)	T / W / H (mm)
For TS35x 7.5	5.2 x 60.7 x 36.5	5.2 x 72.4 x 36.5	6.2 x 56.1x 36.5
For TS35x 15	5.2 x 60.7 x 44	5.2 x 72.4x 44	6.2 x 56.1x 44
Accessories (附件)	Cat. No. Qty.	Cat. No. Qty.	Cat. No. Qty.
End Bracket (終端擋板)	SEW35 50	SEW35 50	SEW35 50
End Plate (擋板)	DD-ST2.5/3-D 50	DD-ST2.5/4-D 50	DD-ST4-D 50
Comb Link (邊接式聯接件)	ODFBS2-5 50 ODFBS3-5 50 ODFBS4-5 50 ODFBS5-5 50 ODFBS10-5 10	ODFBS2-5 50 ODFBS3-5 50 ODFBS4-5 50 ODFBS5-5 50 ODFBS10-5 10	ODFBS2-6 50 ODFBS3-6 50 ODFBS4-6 50 ODFBS5-6 50 ODFBS10-6 10
Marking Tags (標記號)	DUC-TMF5 10 (側面 96 位) DUC-TM5 10 (正面 96 位)	DUC-TMF5 10 (側面 96 位) DUC-TM5 10 (正面 96 位)	DUC-TMF6 10 (側面 80 位) DUC-TM6 10 (正面 80 位)
Tool (工具)	DS3 (0.4 x 3.5mm)	DS3 (0.4 x 3.5mm)	DS3 (0.4 x 4.0mm)

Features of Spring Clamp Terminal Blocks 彈片壓接型接線座

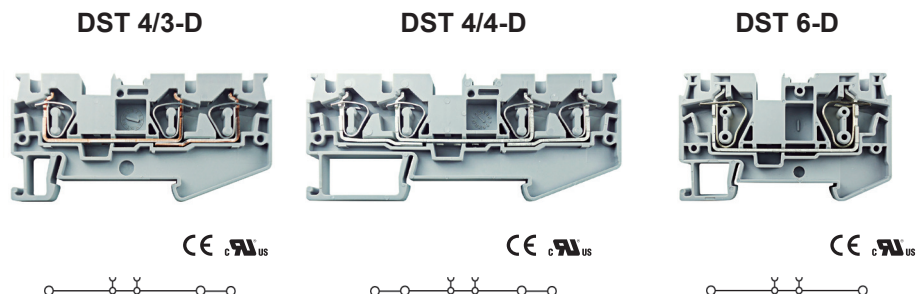

Specifications (產品規格)	4mm ²	4mm ²	6mm ²
Technical Data (技術參數)	Rated voltage / Rated current / Wire Size	Rated voltage / Rated current / Wire Size	Rated voltage / Rated current / Wire Size
UL	600V / 30A / AWG 28-10	600V / 30A / AWG 28-10	600V / 48A / AWG 24-8
CSA	600V / 30A / AWG 28-10	600V / 30A / AWG 28-10	600V / 48A / AWG 24-8
IEC	800V / 40A / 0.08-4mm ²	800V / 40A / 0.08-4mm ²	1000V / 52A / 0.2-6mm ²
Insulating impulse voltage withstand / Pollution degree (額定衝擊電壓 / 污染等級)	8KV / 3	8KV / 3	8KV / 3
Insulation stripping length (mm) (剝線長度)	10mm	10mm	12mm
Material / Available Color (材質顏色)			
Rail Dimensions (導軌尺寸)	T / W / H (mm)	T / W / H (mm)	T / W / H (mm)
For TS35x 7.5	6.2 x 71.7 x 36.5	6.2 x 87.3 x 36.5	8.2 x 69.5 x 43.5
For TS35x 15	6.2 x 71.7 x 44	6.2 x 87.3 x 44	8.2 x 69.5 x 51
Accessories (附件)	Cat. No. Qty.	Cat. No. Qty.	Cat. No. Qty.
End Bracket (終端擋板)	SEW35 50	SEW35 50	SEW35 50
End Plate (擋板)	DD-ST4/3-D 50	DD-ST4/4-D 50	DD-ST6-D 50
Comb Link (邊接式聯接件)	ODFBS2-6 50 ODFBS3-6 50 ODFBS4-6 50 ODFBS5-6 50 ODFBS10-6 10	ODFBS2-6 50 ODFBS3-6 50 ODFBS4-6 50 ODFBS5-6 50 ODFBS10-6 10	ODFBS2-8 50 ODFBS3-8 50 ODFBS4-8 50 ODFBS5-8 50 ODFBS10-8 10
Marking Tags (標記號)	DUC-TMF6 10 (側面 80 位) DUC-TM6 10 (正面 80 位)	DUC-TMF6 10 (側面 80 位) DUC-TM6 10 (正面 80 位)	DUC-TMF8 10 (側面 56 位) DUC-TM8 10 (正面 56 位)
Tool (工具)	DS3 (0.4 x 4.0mm)	DS3 (0.4 x 4.0mm)	DS4 (0.4 x 5.5mm)

Features of Spring Clamp Terminal Blocks 彈片壓接型接線座

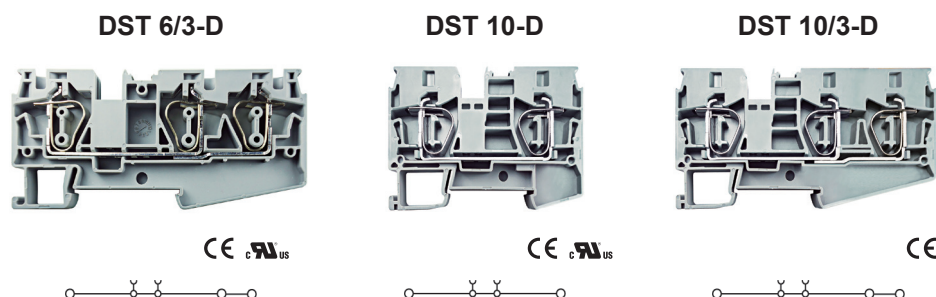

Specifications (產品規格)	6mm ²	10mm ²	10mm ²
Technical Data (技術參數)	Rated voltage / Rated current / Wire Size	Rated voltage / Rated current / Wire Size	Rated voltage / Rated current / Wire Size
UL	600V / 48A / AWG 24-8	600V / 65A / AWG 24-6	600V / 60A / AWG 24-6
CSA	600V / 48A / AWG 24-8	600V / 65A / AWG 24-6	600V / 60A / AWG 24-6
IEC	800V / 52A / 0.2-6mm ²	1000V / 65A / 0.2-10mm ²	1000V / 65A / 0.2-10mm ²
Insulating impulse voltage withstand / Pollution degree (額定衝擊電壓 / 汙染等級)	8KV / 3	8KV / 3	8KV / 3
Insulation stripping length (mm) (剝線長度)	12mm	18mm	18mm
Material / Available Color (材質顏色)			
Rail Dimensions (導軌尺寸)	T / W / H (mm)	T / W / H (mm)	T / W / H (mm)
For TS35x 7.5	8.2 x 90.5 x 43.5	10.2 x 71.3 x 50.5	10.2 x 95.3 x 50.5
For TS35x 15	8.2 x 90.5 x 51	10.2 x 71.3x 58	10.2 x 95.3 x 58
Accessories (附件)	Cat. No. Qty.	Cat. No. Qty.	Cat. No. Qty.
End Bracket (終端擋板)	SEW35 50	SEW35 50	SEW35 50
End Plate (擋板)	DD-ST6/3-D 50	DD-ST10-D 50	DD-ST10/3-D 50
Comb Link (邊接式聯接件)	ODFBS2-8 50 ODFBS3-8 50 ODFBS4-8 50 ODFBS5-8 50 ODFBS10-8 10	ODFBS2-10 10 ODFBS5-10 10	ODFBS2-10 10 ODFBS5-10 10
Marking Tags (標記號)	DUC-TMF8 10 (側面 56 位) DUC-TM8 10 (正面 56 位)	DUC-TMF10 10 (側面 48 位) DUC-TM10 10 (正面 48 位)	DUC-TMF10 10 (側面 48 位) DUC-TM10 10 (正面 48 位)
Tool (工具)	DS4 (0.4 x 5.5mm)	DS5 (0.4 x 6.5mm)	DS5 (0.4 x 6.5mm)



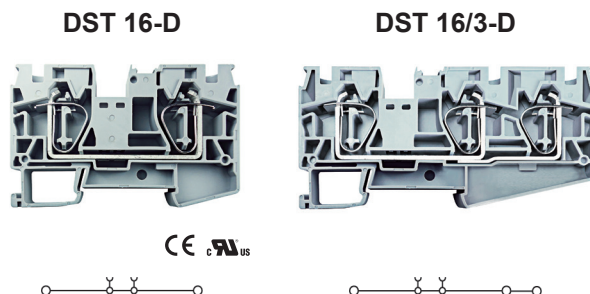



Features of Spring Clamp Terminal Blocks 彈片壓接型接線座

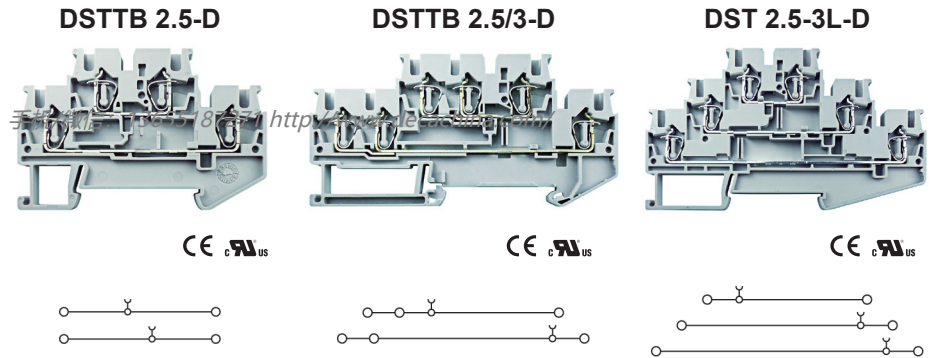

Specifications (產品規格)	16mm ²	16mm ²
Technical Data (技術參數)	Rated voltage / Rated current / Wire Size	
UL	600V / 80A / AWG 24-4	600V / 80A / AWG 24-4
CSA	600V / 80A / AWG 24-4	600V / 80A / AWG 24-4
IEC	1000V / 90A / 0.2-16mm ²	1000V / 90A / 0.2-16mm ²
Insulating impulse voltage withstand / Pollution degree (額定衝擊電壓 / 污染等級)	8KV / 3	8KV / 3
Insulation stripping length (mm) (剝線長度)	18mm	18mm
Material / Available Color (材質顏色)		
Rail Dimensions (導軌尺寸)	T / W / H (mm)	
For TS35x 7.5	12.2 x 80.6 x 51.5	12.2 x 107.8 x 51.5
For TS35x 15	12.2 x 80.6 x 59	12.2 x 107.8 x 59
Accessories (附件)	Cat. No. Qty.	Cat. No. Qty.
End Bracket (終端擋板)	SEW35 50	SEW35 50
End Plate (擋板)	DD-ST16-D 50	DD-ST16/3-D 50
Comb Link (邊接式聯接件)	ODFBS2-12 10	ODFBS2-12 10
Marking Tags (標記號)	DUC-TMF12 10 (側面 40 位) DUC-TM12 10 (正面 40 位)	DUC-TMF12 10 (側面 40 位) DUC-TM12 10 (正面 40 位)
Tool (工具)	DS5 (0.4 x 6.5mm)	DS5 (0.4 x 6.5mm)

Features of Spring Clamp Terminal Blocks 彈片壓接型接線座



Specifications (產品規格)	2.5mm ²		2.5mm ²		2.5mm ²	
Technical Data (技術參數)	Rated voltage / Rated current / Wire Size		Rated voltage / Rated current / Wire Size		Rated voltage / Rated current / Wire Size	
UL	600V / 20A / AWG 28-12		300V / 20A / AWG 28-12		600V / 20A / AWG 28-12	
CSA	600V / 20A / AWG 28-12		300V / 20A / AWG 28-12		600V / 20A / AWG 28-12	
IEC	500V / 26A / 0.08-2.5mm ²		500V / 26A / 0.08-2.5mm ²		500V / 26A / 0.08-2.5mm ²	
Insulating impulse voltage withstand / Pollution degree (額定衝擊電壓 / 汙染等級)	6KV / 3		6KV / 3		6KV / 3	
Insulation stripping length (mm) (剝線長度)	10mm		10mm		10mm	
Material / Available Color (材質顏色)	● ● ● ● ●		● ● ● ● ●		● ● ● ● ●	
Rail Dimensions (導軌尺寸)	T / W / H (mm)		T / W / H (mm)		T / W / H (mm)	
For TS35x 7.5 	5.2 x 67.8 x 47.7		5.2 x 91.3 x 47.7		5.2 x 99.6 x 58	
For TS35x 15 	5.2 x 67.8 x 54.9		5.2 x 91.3 x 54.9		5.2 x 99.6 x 65.5	
Accessories (附件)	Cat. No.	Qty.	Cat. No.	Qty.	Cat. No.	Qty.
End Bracket (終端擋板) 	SEW35	50	SEW35	50	SEW35	50
End Plate (擋板) 	DD-STTB2.5-D	50	DD-STTB2.5/3-D	50	DD-ST2.5-3L-D	50
Comb Link (邊接式聯接件) 	ODFBS2-5	50	ODFBS2-5	50	ODFBS2-5	50
	ODFBS3-5	50	ODFBS3-5	50	ODFBS3-5	50
	ODFBS4-5	50	ODFBS4-5	50	ODFBS4-5	50
	ODFBS5-5	50	ODFBS5-5	50	ODFBS5-5	50
	ODFBS10-5	10	ODFBS10-5	10	ODFBS10-5	10
Marking Tags (標記號) 	DUC-TMF5	10 (側面 96 位)	DUC-TMF5	10 (側面 96 位)	DUC-TMF5	10 (側面 96 位)
	DUC-TM5	10 (正面 96 位)	DUC-TM5	10 (正面 96 位)	DUC-TM5	10 (正面 96 位)
Tool (工具) 	DS3 (0.4 x 3.5mm)		DS3 (0.4 x 3.5mm)		DS3 (0.4 x 3.5mm)	

Features of Spring Clamp Terminal Blocks 彈片壓接型接線座

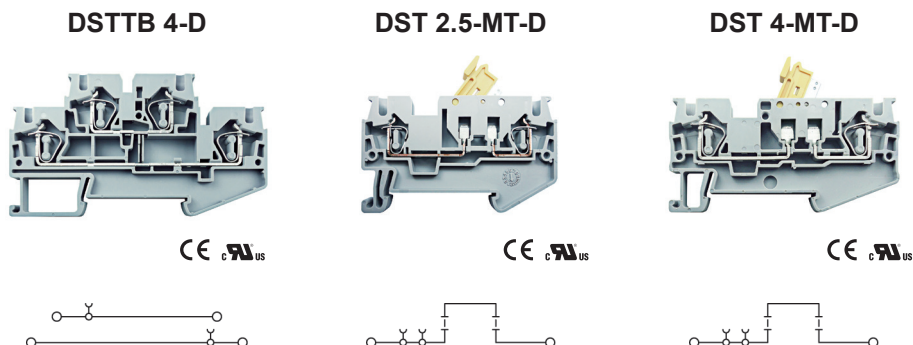

Specifications (產品規格)	2.5mm ²	2.5mm ²	4mm ²
Technical Data (技術參數)	Rated voltage / Rated current / Wire Size		
UL	600V / 30A / AWG 28-10	600V / 16A / AWG 28-12	600V / 21A / AWG 28-10
CSA	600V / 30A / AWG 28-10	600V / 16A / AWG 28-12	600V / 21A / AWG 28-10
IEC	500V / 32A / 0.08-4mm ²	400V / 20A / 0.08-2.5mm ²	400V / 20A / 0.08-4mm ²
Insulating impulse voltage withstand / Pollution degree (額定衝擊電壓 / 污染等級)	6KV / 3	6KV / 3	6KV / 3
Insulation stripping length (mm) (剝線長度)	10mm	10mm	10mm
Material / Available Color (材質顏色)			
Rail Dimensions (導軌尺寸)	T / W / H (mm)		
For TS35x 7.5	6.2 x 83.7 x 47.5	5.2 x 60.6 x 36.5	6.2 x 71.7 x 36.5
For TS35x 15	6.2 x 83.7 x 55	5.2 x 60.6x 44	6.2 x 71.7 x 44
Accessories (附件)	Cat. No. Qty.	Cat. No. Qty.	Cat. No. Qty.
End Bracket (終端擋板)	SEW35 50	SEW35 50	SEW35 50
End Plate (擋板)	DD-STTB4-D 50	DD-ST2.5/3-D 50	DD-ST4/3-D 50
Comb Link (邊接式聯接件)	ODFBS2-6 50 ODFBS3-6 50 ODFBS4-6 50 ODFBS5-6 50 ODFBS10-6 10	ODFBS2-5 50 ODFBS3-5 50 ODFBS4-5 50 ODFBS5-5 50 ODFBS10-5 10	ODFBS2-6 50 ODFBS3-6 50 ODFBS4-6 50 ODFBS5-6 50 ODFBS10-6 10
Marking Tags (標記號)	DUC-TMF6 10 (側面 80 位) DUC-TM6 10 (正面 80 位)	DUC-TMF5 10 (側面 96 位) DUC-TM5 10 (正面 96 位)	DUC-TMF6 10 (側面 80 位) DUC-TM6 10 (正面 80 位)
Tool (工具)	DS3 (0.4 x 4.0mm)	DS3 (0.4 x 3.5mm)	DS3 (0.4 x 4.0mm)

Features of Spring Clamp Terminal Blocks 彈片壓接型接線座

DST 4-HESILED24-D

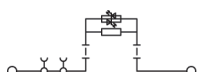
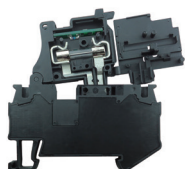



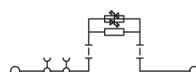
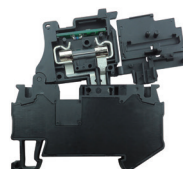

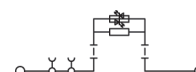

DST 4-HESILED60-D



DST 4-HESILED250-D



Specifications (產品規格)	4mm ²		4mm ²		4mm ²	
Technical Data (技術參數)	Rated voltage / Rated current / Wire Size		Rated voltage / Rated current / Wire Size		Rated voltage / Rated current / Wire Size	
UL	600V / 10A / AWG 28-10		600V / 10A / AWG 28-10		600V / 10A / AWG 28-10	
CSA	600V / 10A / AWG 28-10		600V / 10A / AWG 28-10		600V / 10A / AWG 28-10	
IEC	500V / 6.3A / 0.08-4mm ²		500V / 6.3A / 0.08-4mm ²		500V / 6.3A / 0.08-4mm ²	
Insulating impulse voltage withstand / Pollution degree (額定衝擊電壓 / 污染等級)	4KV / 3		4KV / 3		4KV / 3	
Insulation stripping length (mm) (剝線長度)	10mm		10mm		10mm	
Material / Available Color (材質顏色)	●		●		●	
Rail Dimensions (導軌尺寸)	T / W / H (mm)		T / W / H (mm)		T / W / H (mm)	
For TS35x 7.5 	6.2 x 61.6 x 65		6.2 x 61.6 x 65		6.2 x 61.6 x 65	
For TS35x 15 	6.2 x 61.6 x 72.5		6.2 x 61.6 x 72.5		6.2 x 61.6 x 72.5	
Accessories (附件)	Cat. No.	Qty.	Cat. No.	Qty.	Cat. No.	Qty.
End Bracket (終端擋板) 	SEW35	50	SEW35	50	SEW35	50
End Plate (擋板) 						
Comb Link (邊接式聯接件) 	ODFBS2-6	50	ODFBS2-6	50	ODFBS2-6	50
	ODFBS3-6	50	ODFBS3-6	50	ODFBS3-6	50
	ODFBS4-6	50	ODFBS4-6	50	ODFBS4-6	50
	ODFBS5-6	50	ODFBS5-6	50	ODFBS5-6	50
	ODFBS10-6	10	ODFBS10-6	10	ODFBS10-6	10
Marking Tags (標記號) 	DUC-TMF6	10 (側面 80 位)	DUC-TMF6	10 (側面 80 位)	DUC-TMF6	10 (側面 80 位)
	DUC-TM6	10 (正面 80 位)	DUC-TM6	10 (正面 80 位)	DUC-TM6	10 (正面 80 位)
Tool (工具) 	DS3 (0.4 x 4.0mm)		DS3 (0.4 x 4.0mm)		DS3 (0.4 x 4.0mm)	

Features of Spring Clamp Terminal Blocks 彈片壓接型接線座

DST 4-HEDI-D

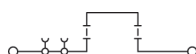
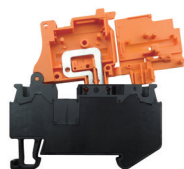

DST 4-HESI-D

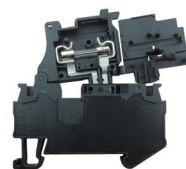

Specifications (產品規格)	4mm ²		4mm ²	
Technical Data (技術參數)	Rated voltage / Rated current / Wire Size		Rated voltage / Rated current / Wire Size	
UL	600V / 10A / AWG 28-10		600V / 10A / AWG 28-10	
CSA	600V / 10A / AWG 28-10		600V / 10A / AWG 28-10	
IEC	500V / 20A / 0.08-4mm ²		500V / 6.3A / 0.08-4mm ²	
Insulating impulse voltage withstand / Pollution degree (額定衝擊電壓 / 污染等級)	6KV / 3		6KV / 3	
Insulation stripping length (mm) (剝線長度)	10mm		10mm	
Material / Available Color (材質顏色)				
Rail Dimensions (導軌尺寸)	T / W / H (mm)		T / W / H (mm)	
For TS35x 7.5	6.2 x 61.6 x 65		6.2 x 61.6 x 65	
For TS35x 15	6.2 x 61.6 x 72.5		6.2 x 61.6 x 72.5	
Accessories (附件)	Cat. No.	Qty.	Cat. No.	Qty.
End Bracket (終端擋板)	SEW35	50	SEW35	50
End Plate (擋板)				
Comb Link (邊接式聯接件)	ODFBS2-6	50	ODFBS2-6	50
	ODFBS3-6	50	ODFBS3-6	50
	ODFBS4-6	50	ODFBS4-6	50
	ODFBS5-6	50	ODFBS5-6	50
	ODFBS10-6	10	ODFBS10-6	10
Marking Tags (標記號)	DUC-TMF6	10 (側面 80 位)	DUC-TMF6	10 (側面 80 位)
	DUC-TM6	10 (正面 80 位)	DUC-TM6	10 (正面 80 位)
Tool (工具)	DS3 (0.4 x 4.0mm)		DS3 (0.4 x 4.0mm)	

Features of Spring Clamp Ground Terminal Blocks 彈片接地型接線座

Features of Spring Clamp Ground Terminal Blocks

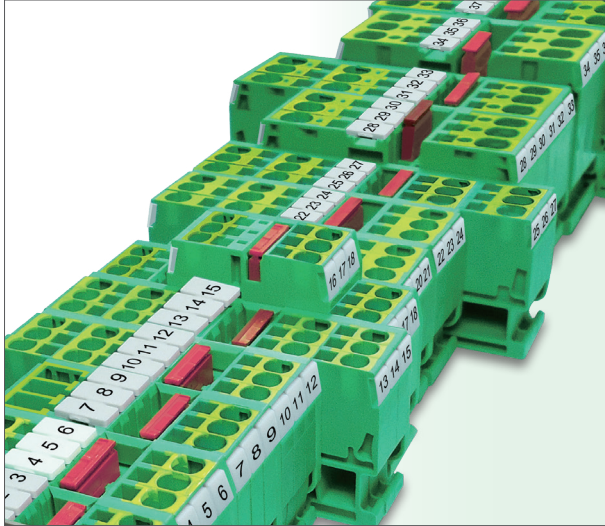

Features of Spring Clamp Ground Terminal Blocks







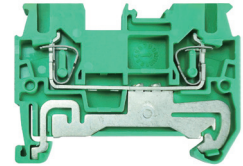
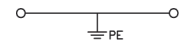

- Vibration proof grounding
- Space-saving design / Front connection.
- Easy to operate, fast wiring installation with top wire entry.
- Corrosion-proof terminal points.
- Easy for the extension of terminal connection.
- Easy handling and safe connection.
- Low contact resistance.
- Easy mounting and dismounting from the terminal rail.

彈片接地型接線座之特性

- 具有抗震及接地之效果
- 節省空間之設計 / 前緣導線連接方式
- 操作簡便且快速的導線安裝方式 (頂部進線)
- 抗腐蝕性佳 (使用良好的金屬材料)
- 容易擴充及延伸性佳
- 操作簡便且連接處安全性高
- 低接觸電阻
- 接線座從軌道上安裝及拆卸容易

DST 1.5-PE-D

CE 

Specifications (產品規格)	1.5mm ²	
Technical Data (技術參數)	Rated voltage / Rated current / Wire Size	
UL	600V / AWG 28-14	
CSA	600V / AWG 28-14	
IEC	500V / 0.08-1.5mm ²	
Insulating impulse voltage withstand / Pollution degree (額定衝擊電壓 / 汙染等級)	6KV / 3	
Insulation stripping length (mm) (剝線長度)	10mm	
Material / Available Color (材質顏色)		
Rail Dimensions (導軌尺寸)	T / W / H (mm)	
For TS35x 7.5 	4.2 x 48.8 x 36.5	
For TS35x 15 	4.2 x 48.8 x 44	
Accessories (附件)	Cat. No.	Qty.
End Bracket (終端擋板) 	SEW35	50
End Plate (擋板) 	DD-ST2.5-DP	50
Comb Link (連接式聯接件) 	ODFBS2-4	50
	ODFBS3-4	50
	ODFBS4-4	50
	ODFBS5-4	50
	ODFBS10-4	10
Marking Tags (標記號) 	DUC-TMF4	10 (側面 120 位)
	DUC-TM4	10 (正面 120 位)
Tool (工具) 	DS2 (0.4 x 2.5mm)	

Features of Spring Clamp Ground Terminal Blocks 彈片接地型接線座

DST 1.5/3-PE-D

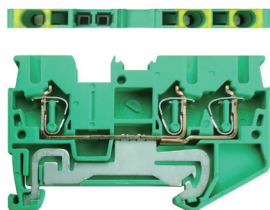

DST 1.5/4-PE-D

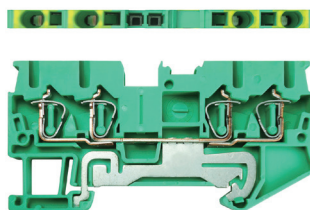

DST 2.5-PE-D

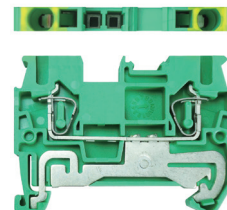

CE cULus

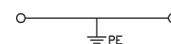
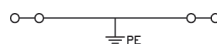
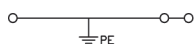

Specifications (產品規格)	1.5mm ²	1.5mm ²	2.5mm ²
Technical Data (技術參數)	Rated voltage / Rated current / Wire Size	Rated voltage / Rated current / Wire Size	Rated voltage / Rated current / Wire Size
UL	600V / AWG 28-14	600V / AWG 28-14	600V / AWG 28-12
CSA	600V / AWG 28-14	600V / AWG 28-14	600V / AWG 28-12
IEC	500V / 0.08-1.5mm ²	500V / 0.08-1.5mm ²	500V / 0.08-2.5mm ²
Insulating Impulse voltage withstand / Pollution degree (額定衝擊電壓 / 汙染等級)	6KV / 3	6KV / 3	8KV / 3
Insulation stripping length (mm) (剝線長度)	10mm	10mm	10mm
Material / Available Color (材質顏色)			
Rail Dimensions (導軌尺寸)	T / W / H (mm)	T / W / H (mm)	T / W / H (mm)
For TS35x 7.5	4.2 x 60.7 x 36.5	4.2 x 72.6 x 36.5	5.2 x 48.8 x 36.5
For TS35x 15	4.2 x 60.7 x 44	4.2 x 72.6 x 44	5.2 x 48.8 x 44
Accessories (附件)	Cat. No. Qty.	Cat. No. Qty.	Cat. No. Qty.
End Bracket (終端擋板)	SEW35 50	SEW35 50	SEW35 50
End Plate (擋板)	DD-ST2.5/3-DP 50	DD-ST2.5/4-DP 50	DD-ST2.5-DP 50
Comb Link (選接式聯接件)	ODFBS2-4 50 ODFBS3-4 50 ODFBS4-4 50 ODFBS5-4 50 ODFBS10-4 10	ODFBS2-4 50 ODFBS3-4 50 ODFBS4-4 50 ODFBS5-4 50 ODFBS10-4 10	ODFBS2-5 50 ODFBS3-5 50 ODFBS4-5 50 ODFBS5-5 50 ODFBS10-5 10
Marking Tags (標記號)	DUC-TMF4 10 (側面 120 位) DUC-TM4 10 (正面 120 位)	DUC-TMF4 10 (側面 120 位) DUC-TM4 10 (正面 120 位)	DUC-TMF5 10 (側面 96 位) DUC-TM5 10 (正面 96 位)
Tool (工具)	DS2 (0.4 x 2.5mm)	DS2 (0.4 x 2.5mm)	DS3 (0.4 x 3.5mm)

Features of Spring Clamp Ground Terminal Blocks 彈片接地型接線座

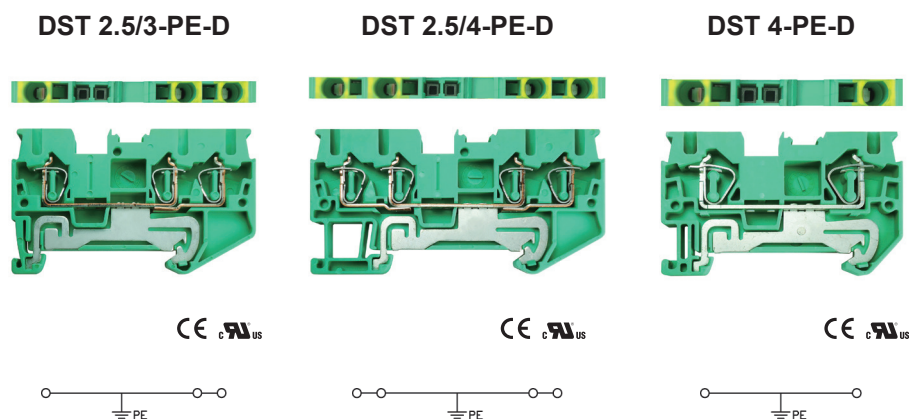

Specifications (產品規格)	2.5mm ²		2.5mm ²		4mm ²	
Technical Data (技術參數)	Rated voltage / Rated current / Wire Size		Rated voltage / Rated current / Wire Size		Rated voltage / Rated current / Wire Size	
UL	600V / AWG 28-12		600V / AWG 28-12		600V / AWG 28-10	
CSA	600V / AWG 28-12		600V / AWG 28-12		600V / AWG 28-10	
IEC	800V / 0.08-2.5mm ²		800V / 0.08-2.5mm ²		800V / 0.08-4mm ²	
Insulating Impulse voltage withstand / Pollution degree (額定衝擊電壓 / 汙染等級)	8KV / 3		8KV / 3		8KV / 3	
Insulation stripping length (mm) (剝線長度)	10mm		10mm		10mm	
Material / Available Color (材質顏色)						
Rail Dimensions (導軌尺寸)	T / W / H (mm)		T / W / H (mm)		T / W / H (mm)	
For TS35x 7.5	5.2 x 60.7 x 36.5		5.2 x 72.4 x 36.5		6.2 x 56.1 x 36.5	
For TS35x 15	5.2 x 60.7 x 44		5.2 x 72.4 x 44		6.2 x 56.1 x 44	
Accessories (附件)	Cat. No.	Qty.	Cat. No.	Qty.	Cat. No.	Qty.
End Bracket (終端擋板)	SEW35	50	SEW35	50	SEW35	50
End Plate (擋板)	DD-ST2.5/3-DP	50	DD-ST2.5/4-DP	50	DD-ST4-DP	50
Comb Link (連接式聯接件)	ODFBS2-5	50	ODFBS2-5	50	ODFBS2-6	50
	ODFBS3-5	50	ODFBS3-5	50	ODFBS3-6	50
	ODFBS4-5	50	ODFBS4-5	50	ODFBS4-6	50
	ODFBS5-5	50	ODFBS5-5	50	ODFBS5-6	50
	ODFBS10-5	10	ODFBS10-5	10	ODFBS10-6	10
Marking Tags (標記號)	DUC-TMF5	10 (側面 96 位)	DUC-TMF5	10 (側面 96 位)	DUC-TMF6	10 (側面 80 位)
	DUC-TM5	10 (正面 96 位)	DUC-TM5	10 (正面 96 位)	DUC-TM6	10 (正面 80 位)
Tool (工具)	DS3 (0.4 x 3.5mm)		DS3 (0.4 x 3.5mm)		DS3 (0.4 x 4.0mm)	

Features of Spring Clamp Ground Terminal Blocks 彈片接地型接線座

DST 4/3-PE-D

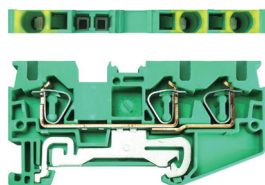

CE

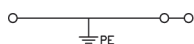

DST 4/4-PE-D

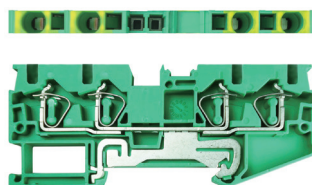

CE

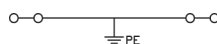

DST 6-PE-D

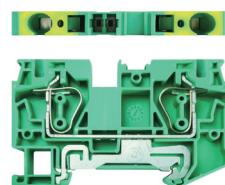

CE

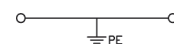

Specifications (產品規格)	4mm ²	4mm ²	6mm ²
Technical Data (技術參數)	Rated voltage / Rated current / Wire Size	Rated voltage / Rated current / Wire Size	Rated voltage / Rated current / Wire Size
UL	600V / AWG 28-10	600V / AWG 28-10	600V / AWG 24-8
CSA	600V / AWG 28-10	600V / AWG 28-10	600V / AWG 24-8
IEC	800V / 0.08-4mm ²	800V / 0.08-4mm ²	1000V / 0.2-6mm ²
Insulating Impulse voltage withstand / Pollution degree (額定衝擊電壓 / 汙染等級)	8KV / 3	8KV / 3	8KV / 3
Insulation stripping length (mm) (剝線長度)	10mm	10mm	12mm
Material / Available Color (材質顏色)			
Rail Dimensions (導軌尺寸)	T / W / H (mm)	T / W / H (mm)	T / W / H (mm)
For TS35x 7.5	6.2 x 71.7 x 36.5	6.2 x 87.3 x 36.5	8.2 x 69.5 x 43.5
For TS35x 15	6.2 x 71.7 x 44	6.2 x 87.3 x 44	8.2 x 69.5 x 51
Accessories (附件)	Cat. No. Qty.	Cat. No. Qty.	Cat. No. Qty.
End Bracket (終端擋板)	SEW35 50	SEW35 50	SEW35 50
End Plate (擋板)	DD-ST4/3-DP 50	DD-ST4/4-DP 50	DD-ST6-DP 50
Comb Link (選接式聯接件)	ODFBS2-6 50 ODFBS3-6 50 ODFBS4-6 50 ODFBS5-6 50 ODFBS10-6 10	ODFBS2-6 50 ODFBS3-6 50 ODFBS4-6 50 ODFBS5-6 50 ODFBS10-6 10	ODFBS2-8 50 ODFBS3-8 50 ODFBS4-8 50 ODFBS5-8 50 ODFBS10-8 10
Marking Tags (標記號)	DUC-TMF6 10 (側面 80 位) DUC-TM6 10 (正面 80 位)	DUC-TMF6 10 (側面 80 位) DUC-TM6 10 (正面 80 位)	DUC-TMF8 10 (側面 56 位) DUC-TM8 10 (正面 56 位)
Tool (工具)	DS3 (0.4 x 4.0mm)	DS3 (0.4 x 4.0mm)	DS4 (0.4 x 5.5mm)

Features of Spring Clamp Ground Terminal Blocks 彈片接地型接線座

DST 6/3-PE-D

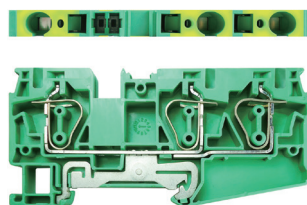

CE cULus

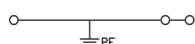

DST 10-PE-D

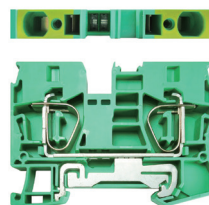

CE cULus

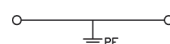

DST 10/3-PE-D

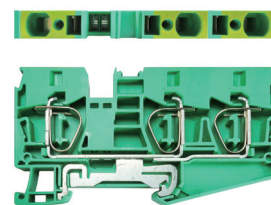

CE

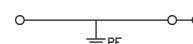

Specifications (產品規格)	6mm ²	10mm ²	10mm ²
Technical Data (技術參數)	Rated voltage / Rated current / Wire Size	Rated voltage / Rated current / Wire Size	Rated voltage / Rated current / Wire Size
UL	600V / AWG 24-8	600V / AWG 24-6	600V / AWG 24-6
CSA	600V / AWG 24-8	600V / AWG 24-6	600V / AWG 24-6
IEC	1000V / 0.2-6mm ²	1000V / 0.2-10mm ²	1000V / 0.2-10mm ²
Insulating Impulse voltage withstand / Pollution degree (額定衝擊電壓 / 污染等級)	8KV / 3	8KV / 3	8KV / 3
Insulation stripping length (mm) (剝線長度)	12mm	18mm	18mm
Material / Available Color (材質顏色)			
Rail Dimensions (導軌尺寸)	T / W / H (mm)	T / W / H (mm)	T / W / H (mm)
For TS35x 7.5	8.2 x 90.5 x 43.5	10.2 x 71.3 x 50.5	10.2 x 95.3 x 50.5
For TS35x 15	8.2 x 90.5 x 51	10.2 x 71.3 x 58	10.2 x 95.3 x 58
Accessories (附件)	Cat. No. Qty.	Cat. No. Qty.	Cat. No. Qty.
End Bracket (終端擋板)	SEW35 50	SEW35 50	SEW35 50
End Plate (擋板)	DD-ST6/3-DP 50	DD-ST10-DP 50	DD-ST10/3-DP 50
Comb Link (連接式聯接件)	ODFBS2-8 50 ODFBS3-8 50 ODFBS4-8 50 ODFBS5-8 50 ODFBS10-8 10	ODFBS2-10 10 ODFBS5-10 10	ODFBS2-10 10 ODFBS5-10 10
Marking Tags (標記號)	DUC-TMF8 10 (側面 56 位) DUC-TM8 10 (正面 56 位)	DUC-TMF10 10 (側面 48 位) DUC-TM10 10 (正面 48 位)	DUC-TMF10 10 (側面 48 位) DUC-TM10 10 (正面 48 位)
Tool (工具)	DS3 (0.4 x 5.5mm)	DS5 (0.4 x 6.5mm)	DS5 (0.4 x 6.5mm)

Features of Spring Clamp Ground Terminal Blocks 彈片接地型接線座

DST 16-PE-D

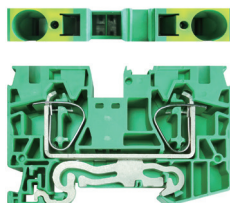

DST 16/3-PE-D

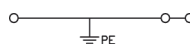
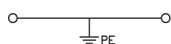
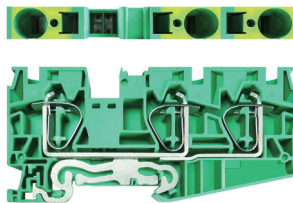

Specifications (產品規格)	16mm ²	16mm ²
Technical Data (技術參數)	Rated voltage / Rated current / Wire Size	Rated voltage / Rated current / Wire Size
UL	600V / AWG 24-4	600V / AWG 24-4
CSA	600V / AWG 24-4	600V / AWG 24-4
IEC	1000V / 0.2-16mm ²	1000V / 0.2-16mm ²
Insulating impulse voltage withstand / Pollution degree (額定衝擊電壓 / 汙染等級)	8KV / 3	8KV / 3
Insulation stripping length (mm) (剝線長度)	18mm	18mm
Material / Available Color (材質顏色)		
Rail Dimensions (導軌尺寸)	T / W / H (mm)	T / W / H (mm)
For TS35x 7.5	12.2 x 80.6 x 51.5	12.2 x 107.8 x 51.5
For TS35x 15	12.2 x 80.6 x 59	12.2 x 107.8 x 59
Accessories (附件)	Cat. No. Qty.	Cat. No. Qty.
End Bracket (終端擋板)	SEW35 50	SEW35 50
End Plate (擋板)	DD-ST16-DP 50	DD-ST16/3-DP 50
Comb Link (邊接式聯接件)	ODFBS2-12 10	ODFBS2-12 10
Marking Tags (標記號)	DUC-TMF12 10 (側面 40 位) DUC-TM12 10 (正面 40 位)	DUC-TMF12 10 (側面 40 位) DUC-TM12 10 (正面 40 位)
Tool (工具)	DS5 (0.4 x 6.5mm)	DS5 (0.4 x 6.5mm)

Features of Spring Clamp Ground Terminal Blocks 彈片接地型接線座

DSTTB 2.5-PE-D

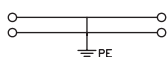
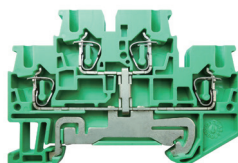

Specifications (產品規格)	2.5mm ²	
Technical Data (技術參數)	Rated voltage / Rated current / Wire Size	
UL	600V / AWG 28-12	
CSA	600V / AWG 28-12	
IEC	800V / 0.08-2.5mm ²	
Insulating Impulse voltage withstand / Pollution degree (額定衝擊電壓 / 污染等級)	6KV / 3	
Insulation stripping length (mm) (剝線長度)	10mm	
Material / Available Color (材質顏色)		
Rail Dimensions (導軌尺寸)	T / W / H (mm)	
For TS35x 7.5	5.2 x 67.8 x 47.4	
For TS35x 15	5.2 x 67.8 x 54.9	
Accessories (附件)	Cat. No.	Qty.
End Bracket (終端擋板)	SEW35	50
End Plate (擋板)	DD-STTB2.5-DP	50
Comb Link (連接式聯接件)	ODFBS2-5	50
	ODFBS3-5	50
	ODFBS4-5	50
	ODFBS5-5	50
	ODFBS10-5	10
Marking Tags (標記號)	DUC-TMF5	10 (側面 96 位)
	DUC-TM5	10 (正面 96 位)
Tool (工具)	DS3 (0.4 x 3.5mm)	

Push In Spring Clamp Terminal Blocks 推入式彈片壓接型接線座

PUSH IN SREIES

Push In Spring Clamp Terminal Blocks

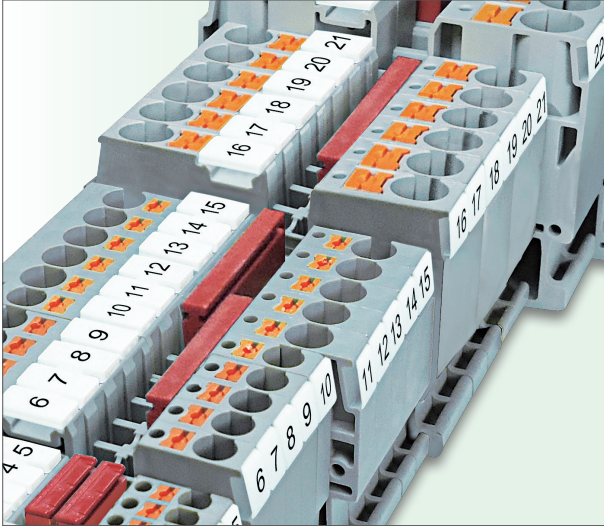

Push In Spring Clamp Terminal Blocks



- Space-saving design / Front connection.
- Vibration proof anti-loosening wire connection with pre-stressed Spring Clamp.
- Easy to operate, fast wiring installation with top wire entry.
- Easy mounting and dismounting from the terminal rail.
- Corrosion-proof terminal points.
- Low contact resistance.
- Easy for the extension of terminal connection.
- Easy handling and safe connection.
- Connecting without tools, easy and time-saving.
- Colored platens ensure safety connections and operations.

推入式彈片壓接型接線座

- 節省空間之特性 / 前緣導線連接方式
- 高強度壓力的彈度迫緊連接方式，具有抗震與防鬆的效果
- 操作簡便且快速的導線安裝方式（頂部進線）
- 抗腐蝕性佳（使用良好的金屬材料）
- 接線座從軌道上安裝及拆卸容易
- 低接觸電阻
- 容易擴充及延伸性佳
- 操作簡便且連接處安全性高
- 連接導線無需工具即可，輕鬆、節省時間
- 帶顏色的退線按鈕，確保安全接線和操作

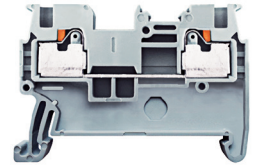





DPT 1.5

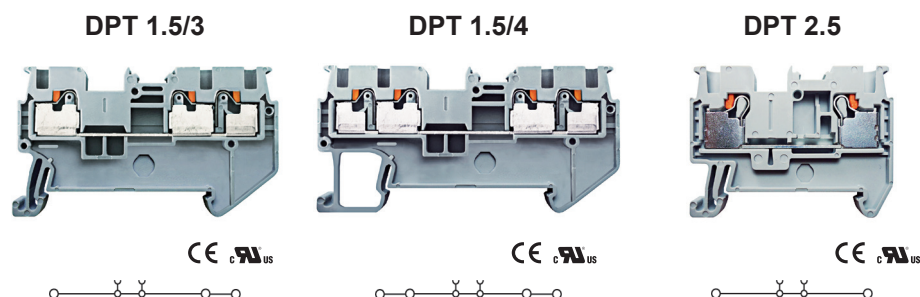

Specifications (產品規格)	1.5mm ²	
Technical Data (技術參數)	Rated voltage / Rated current / Wire Size	
UL	600V / 15A / AWG 26-14	
CSA	600V / 15A / AWG 26-14	
IEC	500V / 17.5A / 0.14-1.5mm ²	
Insulating impulse voltage withstand / Pollution degree (額定衝擊電壓 / 汙染等級)	6KV / 3	
Insulation stripping length (mm) (剝線長度)	10mm	
Material / Available Color (材質顏色)	● ● ● ● ●	
Rail Dimensions (導軌尺寸)	T / W / H (mm)	
For TS35x 7.5 	3.5 x 45 x 32	
For TS35x 15 	3.5 x 45 x 39.5	
Accessories (附件)	Cat. No.	Qty.
End Bracket (終端擋板) 	SEW35	50
End Plate (擋板) 	DD-PT1.5-D	50
Comb Link (邊接式聯接件) 	ODFBS2-3.5	50
	ODFBS3-3.5	50
	ODFBS4-3.5	50
	ODFBS5-3.5	50
	ODFBS10-3.5	10
Marking Tags (標記號) 	DUC-TMF3.5	10 (側面 144 位)
	DUC-TM3.5	10 (正面 144 位)
Tool (工具) 	DS2 (0.4 x 2.0mm)	

Push In Spring Clamp Terminal Blocks 推入式彈片壓接型接線座



Specifications (產品規格)	1.5mm ²		1.5mm ²		2.5mm ²	
Technical Data (技術參數)	Rated voltage / Rated current / Wire Size		Rated voltage / Rated current / Wire Size		Rated voltage / Rated current / Wire Size	
UL	600V / 15A / AWG 26-14		600V / 15A / AWG 26-14		600V / 20A / AWG 26-12	
CSA	600V / 15A / AWG 26-14		600V / 15A / AWG 26-14		600V / 20A / AWG 26-12	
IEC	500V / 17.5A / 0.14-1.5mm ²		500V / 17.5A / 0.14-1.5mm ²		800V / 24A / 0.14-2.5mm ²	
Insulating impulse voltage withstand / Pollution degree (額定衝擊電壓 / 汙染等級)	6KV / 3		6KV / 3		8KV / 3	
Insulation stripping length (mm) (剝線長度)	10mm		10mm		10mm	
Material / Available Color (材質顏色)	● ● ● ● ●		● ● ● ● ●		● ● ● ● ●	
Rail Dimensions (導軌尺寸)	T / W / H (mm)		T / W / H (mm)		T / W / H (mm)	
For TS35x 7.5 	3.5 x 54.1 x 32		3.5 x 63.2 x 32		5.2 x 48.5 x 36.5	
For TS35x 15 	3.5 x 54.1 x 39.5		3.5 x 63.2 x 39.5		5.2 x 48.5 x 44	
Accessories (附件)	Cat. No.	Qty.	Cat. No.	Qty.	Cat. No.	Qty.
End Bracket (終端擋板) 	SEW35	50	SEW35	50	SEW35	50
End Plate (擋板) 	DD-PT1.5/3-D	50	DD-PT1.5/4-D	50	DD-PT2.5-D	50
Comb Link (邊接式聯接件) 	ODFBS2-3.5	50	ODFBS2-3.5	50	ODFBS2-5	50
	ODFBS3-3.5	50	ODFBS3-3.5	50	ODFBS3-5	50
	ODFBS4-3.5	50	ODFBS4-3.5	50	ODFBS4-5	50
	ODFBS5-3.5	50	ODFBS5-3.5	50	ODFBS5-5	50
	ODFBS10-3.5	10	ODFBS10-3.5	10	ODFBS10-5	10
Marking Tags (標記號) 	DUC-TMF3.5	10 (側面 144 位)	DUC-TMF3.5	10 (側面 144 位)	DUC-TMF5	10 (側面 96 位)
	DUC-TM3.5	10 (正面 144 位)	DUC-TM3.5	10 (正面 144 位)	DUC-TM5	10 (正面 96 位)
Tool (工具) 	DS2 (0.4 x 2.0mm)		DS2 (0.4 x 2.0mm)		DS3 (0.4*3.5mm)	

Push In Spring Clamp Terminal Blocks 推入式彈片壓接型接線座

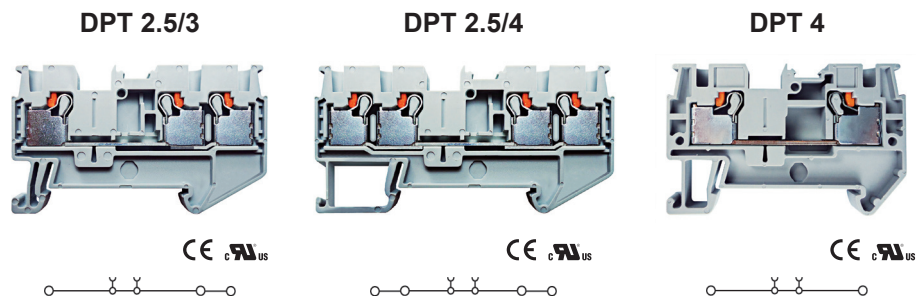

Specifications (產品規格)	2.5mm ²	2.5mm ²	4mm ²
Technical Data (技術參數)	Rated voltage / Rated current / Wire Size		
UL	600V / 20A / AWG 26-12	600V / 20A / AWG 26-12	600V / 30A / AWG 24-10
CSA	600V / 20A / AWG 26-12	600V / 20A / AWG 26-12	600V / 30A / AWG 24-10
IEC	800V / 24A / 0.14-2.5mm ²	800V / 24A / 0.14-2.5mm ²	800V / 32A / 0.2-4mm ²
Insulating impulse voltage withstand / Pollution degree (額定衝擊電壓 / 汙染等級)	8KV / 3	8KV / 3	8KV / 3
Insulation stripping length (mm) (剝線長度)	10mm	10mm	10mm
Material / Available Color (材質顏色)			
Rail Dimensions (導軌尺寸)	T / W / H (mm)		
For TS35x 7.5	5.2 x 60.7 x 36.5	5.2 x 72.4 x 36.5	6.2 x 56.1 x 36.5
For TS35x 15	5.2 x 60.7 x 44	5.2 x 72.4 x 44	6.2 x 56.1 x 44
Accessories (附件)	Cat. No. Qty.	Cat. No. Qty.	Cat. No. Qty.
End Bracket (終端擋板)	SEW35 50	SEW35 50	SEW35 50
End Plate (擋板)	DD-PT2.5/3-D 50	DD-PT2.5/4-D 50	DD-PT4-D 50
Comb Link (邊接式聯接件)	ODFBS2-5 50	ODFBS2-5 50	ODFBS2-6 50
	ODFBS3-5 50	ODFBS3-5 50	ODFBS3-6 50
	ODFBS4-5 50	ODFBS4-5 50	ODFBS4-6 50
	ODFBS5-5 50	ODFBS5-5 50	ODFBS5-6 50
	ODFBS10-5 10	ODFBS10-5 10	ODFBS10-6 10
Marking Tags (標記號)	DUC-TMF5 10 (側面 96 位)	DUC-TMF5 10 (側面 96 位)	DUC-TMF6 10 (側面 80 位)
	DUC-TM5 10 (正面 96 位)	DUC-TM5 10 (正面 96 位)	DUC-TM6 10 (正面 80 位)
Tool (工具)	DS3 (0.4 x 3.5mm)	DS3 (0.4 x 3.5mm)	DS3 (0.4 x 3.5mm)

Push In Spring Clamp Terminal Blocks 推入式彈片壓接型接線座

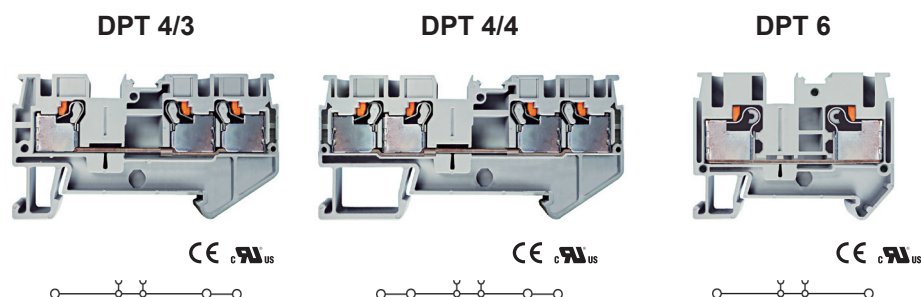

Specifications (產品規格)	4mm ²	4mm ²	6mm ²
Technical Data (技術參數)	Rated voltage / Rated current / Wire Size	Rated voltage / Rated current / Wire Size	Rated voltage / Rated current / Wire Size
UL	600V / 30A / AWG 24-10	600V / 30A / AWG 24-10	600V / 43A / AWG 20-8
CSA	600V / 30A / AWG 24-10	600V / 30A / AWG 24-10	600V / 43A / AWG 20-8
IEC	800V / 32A / 0.2-4mm ²	800V / 32A / 0.2-4mm ²	1000V / 41A / 0.5-6mm ²
Insulating impulse voltage withstand / Pollution degree (額定衝擊電壓 / 汙染等級)	8KV / 3	8KV / 3	8KV / 3
Insulation stripping length (mm) (剝線長度)	10mm	10mm	12mm
Material / Available Color (材質顏色)			
Rail Dimensions (導軌尺寸)	T / W / H (mm)	T / W / H (mm)	T / W / H (mm)
For TS35x 7.5	6.2 x 66.5 x 36.5	6.2 x 77 x 36.5	8.2 x 57.7 x 43.5
For TS35x 15	6.2 x 66.5 x 44	6.2 x 77 x 44	8.2 x 57.7 x 51
Accessories (附件)	Cat. No. Qty.	Cat. No. Qty.	Cat. No. Qty.
End Bracket (終端擋板)	SEW35 50	SEW35 50	SEW35 50
End Plate (擋板)	DD-PT4/3-D 50	DD-PT4/4-D 50	DD-PT6-D 50
Comb Link (邊接式聯接件)	ODFBS2-6 50 ODFBS3-6 50 ODFBS4-6 50 ODFBS5-6 50 ODFBS10-6 10	ODFBS2-6 50 ODFBS3-6 50 ODFBS4-6 50 ODFBS5-6 50 ODFBS10-6 10	ODFBS2-8 50 ODFBS3-8 50 ODFBS4-8 50 ODFBS5-8 50 ODFBS10-8 50
Marking Tags (標記號)	DUC-TMF6 10 (側面 80 位) DUC-TM6 10 (正面 80 位)	DUC-TMF6 10 (側面 80 位) DUC-TM6 10 (正面 80 位)	DUC-TMF8 10 (側面 56 位) DUC-TM8 10 (正面 56 位)
Tool (工具)	DS3 (0.4 x 3.5mm)	DS3 (0.4 x 3.5mm)	DS4 (0.4 x 5.5mm)

Push In Spring Clamp Terminal Blocks 推入式彈片壓接型接線座

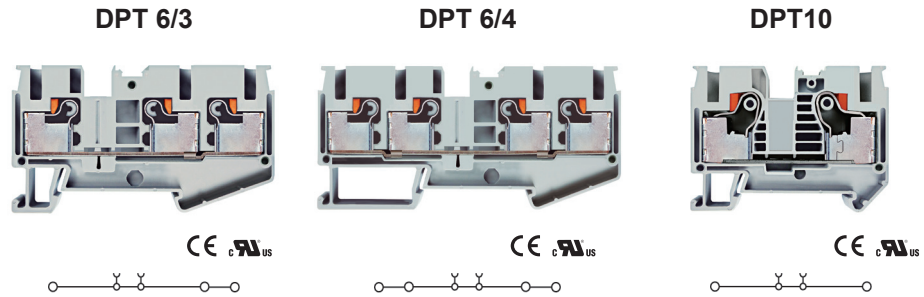

Specifications (產品規格)	6mm ²	6mm ²	10mm ²
Technical Data (技術參數)	Rated voltage / Rated current / Wire Size	Rated voltage / Rated current / Wire Size	Rated voltage / Rated current / Wire Size
UL	600V / 43A / AWG 20-8	600V / 43A / AWG 20-8	600V / 60A / AWG 20-6
CSA	600V / 43A / AWG 20-8	600V / 43A / AWG 20-8	600V / 60A / AWG 20-6
IEC	1000V / 41A / 0.5-6mm ²	1000V / 41A / 0.5-6mm ²	1000V / 57A / 0.5-10mm ²
Insulating impulse voltage withstand / Pollution degree (額定衝擊電壓 / 污染等級)	8KV / 3	8KV / 3	8KV / 3
Insulation stripping length (mm) (剝線長度)	12mm	12mm	18mm
Material / Available Color (材質顏色)			
Rail Dimensions (導軌尺寸)	T / W / H (mm)	T / W / H (mm)	T / W / H (mm)
For TS35x 7.5	8.2 x 74.2 x 43.5	8.2 x 90.6 x 43.5	10.2 x 67.7 x 50.5
For TS35x 15	8.2 x 74.2 x 51	8.2 x 90.6 x 51	10.2 x 67.7 x 58
Accessories (附件)	Cat. No. Qty.	Cat. No. Qty.	Cat. No. Qty.
End Bracket (終端擋板)	SEW35 50	SEW35 50	SEW35 50
End Plate (擋板)	DD-PT6/3-D 50	DD-PT6/4-D 50	DD-PT10-D 50
Comb Link (邊接式聯接件)	ODFBS2-8 50 ODFBS3-8 50 ODFBS4-8 50 ODFBS5-8 50 ODFBS10-8 10	ODFBS2-8 50 ODFBS3-8 50 ODFBS4-8 50 ODFBS5-8 50 ODFBS10-8 10	ODFBS2-10 10 ODFBS5-10 10
Marking Tags (標記號)	DUC-TMF8 10 (側面 56 位) DUC-TM8 10 (正面 56 位)	DUC-TMF8 10 (側面 56 位) DUC-TM8 10 (正面 56 位)	DUC-TMF10 10 (側面 48 位) DUC-TM10 10 (正面 48 位)
Tool (工具)	DS4 (0.4 x 5.5mm)	DS4 (0.4 x 5.5mm)	DS50 (0.4 x 6.5mm)

Push In Spring Clamp Terminal Blocks 推入式彈片壓接型接線座

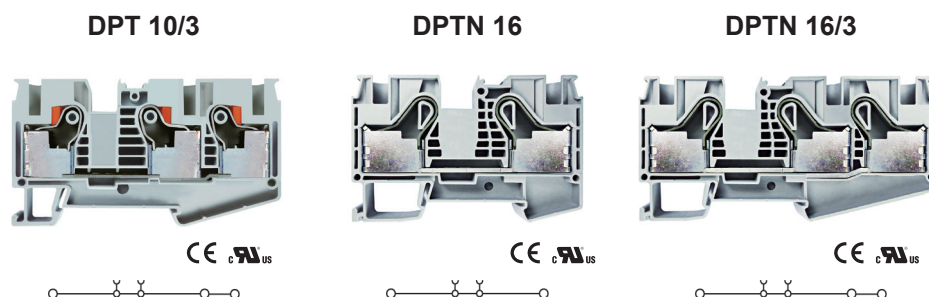

Specifications (產品規格)	10mm ²	16mm ²	16mm ²
Technical Data (技術參數)	Rated voltage / Rated current / Wire Size	Rated voltage / Rated current / Wire Size	Rated voltage / Rated current / Wire Size
UL	600V / 60A / AWG 20-6	600V / 85A / AWG 20-4	600V / 85A / AWG 20-4
CSA	600V / 60A / AWG 20-6	600V / 85A / AWG 20-4	600V / 85A / AWG 20-4
IEC	1000V / 57A / 0.5-10mm ²	1000V / 76A / 0.5-16mm ²	1000V / 76A / 0.5-16mm ²
Insulating impulse voltage withstand / Pollution degree (額定衝擊電壓 / 汙染等級)	8KV / 3	8KV / 3	8KV / 3
Insulation stripping length (mm) (剝線長度)	18mm	18mm	18mm
Material / Available Color (材質顏色)			
Rail Dimensions (導軌尺寸)	T / W / H (mm)	T / W / H (mm)	T / W / H (mm)
For TS35x 7.5	10.2 x 88.9 x 50.5	12.2 x 77.6 x 51.5	12.2 x 104 x 51.5
For TS35x 15	10.2 x 88.9 x 58	12.2 x 77.6 x 59	12.2 x 104 x 59
Accessories (附件)	Cat. No. Qty.	Cat. No. Qty.	Cat. No. Qty.
End Bracket (終端擋板)	SEW35 50	SEW35 50	SEW35 50
End Plate (擋板)	DD-PT10/3-D 50	DD-PTN16-D 50	DD-PTN16/3-D 50
Comb Link (邊接式聯接件)	ODFBS2-10 10 ODFBS5-10 10	ODFBS2-12 10	ODFBS2-12 10
Marking Tags (標記號)	DUC-TMF10 10 (側面 48 位) DUC-TM10 10 (正面 48 位)	DUC-TMF12 10 (側面 40 位) DUC-TM12 10 (正面 40 位)	DUC-TMF12 10 (側面 40 位) DUC-TM12 10 (正面 40 位)
Tool (工具)	DS5 (0.4 x 6.5mm)	DS5 (0.4 x 6.5mm)	DS5 (0.4 x 6.5mm)

Push In Spring Clamp Terminal Blocks 推入式彈片壓接型接線座

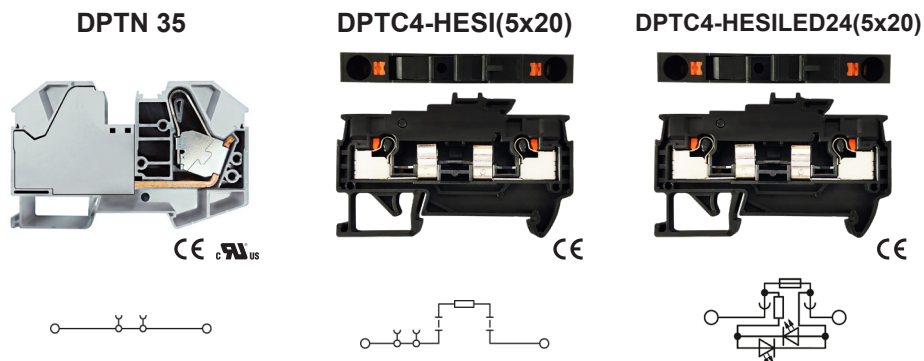

Specifications (產品規格)	35mm ²	4mm ²	4mm ²
Technical Data (技術參數)	Rated voltage / Rated current / Wire Size	Rated voltage / Rated current / Wire Size	Rated voltage / Rated current / Wire Size
UL	600V / 115A / AWG 14-2	無	無
CSA	600V / 115A / AWG 14-2	無	無
IEC	1000V / 125A / 2.5-35mm ²	500V / 6.3A / 0.2-4mm ²	500V / 6.3A / 0.2-4mm ²
Insulating Impulse voltage withstand / Pollution degree (額定衝擊電壓 / 污染等級)	8KV / 3	8KV / 3	8KV / 3
Insulation stripping length (mm) (剝線長度)	25mm	10mm	10mm
Material / Available Color (材質顏色)			
Rail Dimensions (導軌尺寸)	T / W / H (mm)	T / W / H (mm)	T / W / H (mm)
For TS35x 7.5	16 x 100 x 63.2	8.2 x 67.8 x 41.02	8.2 x 67.8 x 41.02
For TS35x 15	16 x 100 x 70.7	8.2 x 67.8 x 48.52	8.2 x 67.8 x 48.52
Accessories (附件)	Cat. No. Qty.	Cat. No. Qty.	Cat. No. Qty.
End Bracket (終端擋板)	SEW35 50	SEW35 50	SEW35 50
End Plate (擋板)		DD-PTC4-HESI-D	DD-PTC4-HESI-D
Comb Link (連接式聯接件)	ODFBS2-16 10	無	無
Marking Tags (標記號)	DUC-TMF16 10 (側面 32 位) DUC-TM16 10 (正面 32 位)	DUC-TMF8 10 (側面 56 位) DUC-TMF6 10 (側面 80 位)	DUC-TMF8 10 (側面 56 位) DUC-TMF6 10 (側面 80 位)
Tool (工具)	DS5 (0.4 x 8.0mm)	DS2 (0.4 x 3.5mm)	DS2 (0.4 x 3.5mm)

Push In Spring Clamp Terminal Blocks 推入式彈片壓接型接線座

DPTTB 1.5

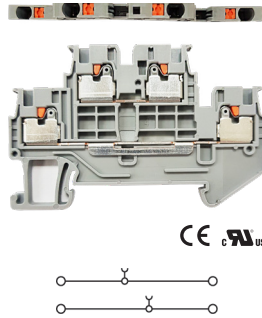

DPTTB 2.5

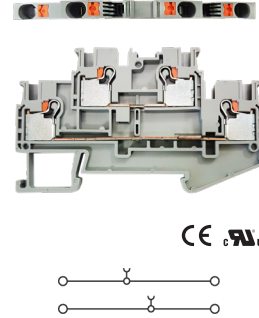

DPTTB 4

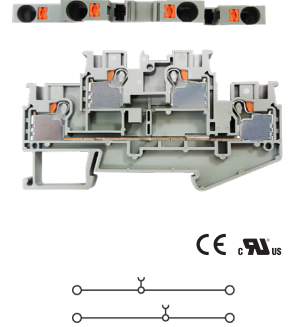

Specifications (產品規格)	1.5mm ²	2.5mm ²	4mm ²
Technical Data (技術參數)	Rated voltage / Rated current / Wire Size	Rated voltage / Rated current / Wire Size	Rated voltage / Rated current / Wire Size
UL	600V / 15A / AWG 26-14	600V / 20A / AWG 28-12	600V / 30A / AWG 24-10
CSA	600V / 15A / AWG 26-14	600V / 20A / AWG 28-12	600V / 30A / AWG 24-10
IEC	500V / 17.5A / 0.14-1.5mm ²	800V / 24A / 0.08-2.5mm ²	800V / 32A / 0.2-4mm ²
Insulating impulse voltage withstand / Pollution degree (額定衝擊電壓 / 汙染等級)	6KV / 3	8KV / 3	8KV / 3
Insulation stripping length (mm) (剝線長度)	10mm	10mm	10mm
Material / Available Color (材質顏色)			
Rail Dimensions (導軌尺寸)	T / W / H (mm)	T / W / H (mm)	T / W / H (mm)
For TS35x 7.5	3.5 x 65.4 x 42.9	5.2 x 78.8 x 47.6	6.2 x 85 x 47.5
For TS35x 15	3.5 x 65.4 x 50.4	5.2 x 78.8 x 55.5	6.2 x 85 x 55
Accessories (附件)	Cat. No. Qty.	Cat. No. Qty.	Cat. No. Qty.
End Bracket (終端擋板)	SEW35 50	SEW35 50	SEW35 50
End Plate (擋板)	DD-PTTB1.5-D	DD-PTTB2.5-D	DD-PTTB4-D
Comb Link (邊接式聯接件)	ODFBS2-3.5 ODFBS3-3.5 ODFBS4-3.5 ODFBS5-3.5 ODFBS10-3.5	ODFBS2-5 ODFBS3-5 ODFBS4-5 ODFBS5-5 ODFBS10-5	ODFBS2-6 ODFBS3-6 ODFBS4-6 ODFBS5-6 ODFBS10-6
Marking Tags (標記號)	DUC-TMF3.5 10 (側面 144 位) DUC-TM3.5 10 (側面 144 位)	DUC-TMF5 10 (側面 96 位) DUC-TM5 10 (正面 96 位)	DUC-TMF6 10 (側面 80 位) DUC-TM6 10 (側面 80 位)
Tool (工具)	DS2 (0.4 x 2.0mm)	DS3 (0.4 x 3.5mm)	DS3 (0.4 x 3.5mm)

Push In Spring Clamp Terminal Blocks 推入式彈片壓接型接線座

DPT2.5/4-DIO/L-R

DPT2.5/4-DIO/R-L

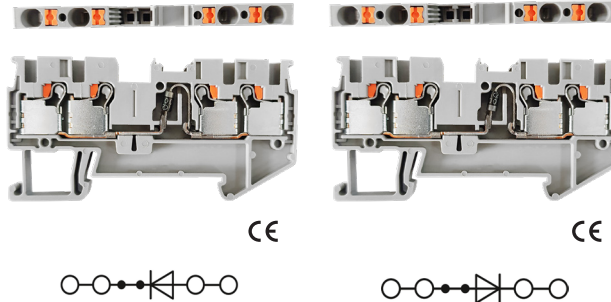

Specifications (產品規格)	2.5mm ²	2.5mm ²
Technical Data (技術參數)	Rated voltage / Rated current / Wire Size	Rated voltage / Rated current / Wire Size
UL	300V / 0.5A / AWG 26-12	300V / 0.5A / AWG 26-12
CSA	300V / 0.5A / AWG 26-12	300V / 0.5A / AWG 26-12
IEC	800V / 0.5A / 0.14-2.5mm ²	800V / 0.5A / 0.14-2.5mm ²
DIODE	IN 4007(1000V 0.5A)	IN 4007(1000V 0.5A)
Insulating Impulse voltage withstand / Pollution degree (額定衝擊電壓 / 污染等級)	8KV / 3	8KV / 3
Insulation stripping length (mm) (剝線長度)	10mm	10mm
Material / Available Color (材質顏色)		
Rail Dimensions (導軌尺寸)	T / W / H (mm)	T / W / H (mm)
For TS35x 7.5	5.2 x 72.2 x 36.8	5.2 x 78.8 x 47.6
For TS35x 15	5.2 x 72.2 x 44.3	5.2 x 78.8 x 55.5
Accessories (附件)	Cat. No.	Cat. No. Qty.
End Bracket (終端擋板)	SEW35	SEW35
End Plate (擋板)	DD-PT2.5/4-D	DD-PT2.5/4-D
Comb Link (邊接式聯接件)	ODDFBS2-5 ODFBS3-5 ODFBS4-5 ODFBS5-5 ODFBS3-10-5	ODDFBS2-5 ODFBS3-5 ODFBS4-5 ODFBS5-5 ODFBS3-10-5
Marking Tags (標記號)	DUC-TMF5 10片 (側面 96位) DUC-TM5 10片 (正面 96位)	DUC-TMF5 10 (側面 96位) DUC-TM5 10 (正面 96位)
Tool (工具)	0.4 x 3.5mm	DS3 (0.4 x 3.5mm)

Push In Spring Clamp Ground Terminal Blocks 推入式彈片接地型接線座

PUSH IN GROUNDING SREIES

Push In Spring Clamp Ground Terminal Blocks

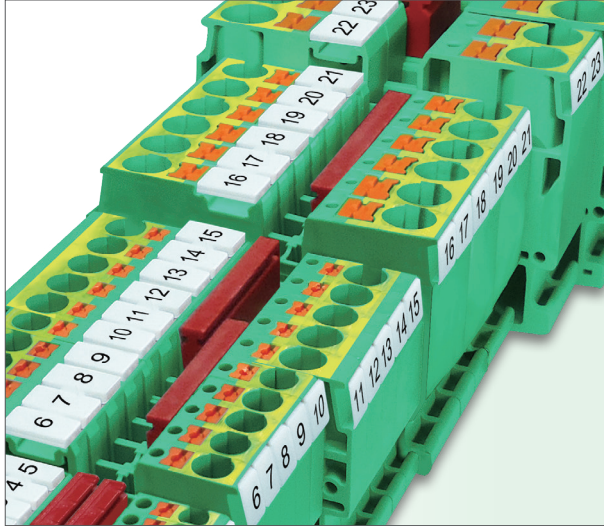

Push In Spring Clamp Ground Terminal Blocks





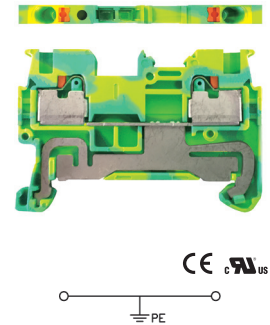

- Vibration proof grounding
- Space-saving design / Front connection.
- Easy to operate, fast wiring installation with top wire entry.
- Corrosion-proof terminal points.
- Easy for the extension of terminal connection.
- Easy handling and safe connection.
- Low contact resistance.
- Easy mounting and dismantling from the terminal rail.
- Connecting without tools, easy and time-saving.
- Colored platens ensure safety connections and operations.

推入式彈片接地型接線座

- 具有抗震及接地之效果
- 節省空間之設計 / 前緣導線連接方式
- 操作簡便且快速的導線安裝方式 (頂部進線)
- 抗腐蝕性佳 (使用良好的金屬材料)
- 容易擴充及延伸性佳
- 操作簡便且連接處安全性高
- 低接觸電阻
- 接線座從軌道上安裝及拆卸容易
- 連接導線無需工具即可，輕鬆、節省時間
- 帶顏色的退線按鈕，確保安全接線和操作

DPT 1.5-PE



Specifications (產品規格)	1.5mm ²		
Technical Data (技術參數)	Rated voltage / Rated current / Wire Size		
UL	600V / AWG 26-14		
CSA	600V / AWG 26-14		
IEC	500V / 0.14-1.5mm ²		
Insulating impulse voltage withstand / Pollution degree (額定衝擊電壓 / 汙染等級)	6KV / 3		
Insulation stripping length (mm) (剝線長度)	10mm		
Material / Available Color (材質顏色)	●		
Rail Dimensions (導軌尺寸)	T / W / H (mm)		
For TS35x 7.5		3.5 x 45 x 32	
For TS35x 15		3.5 x 45 x 39.5	
Accessories (附件)	Cat. No.	Qty.	
End Bracket (終端擋板)	 SEW35	50	
End Plate (擋板)	 DD-PT1.5-DP	50	
Comb Link (邊接式聯接件)		ODFBS2-3.5	50
		ODFBS3-3.5	50
		ODFBS4-3.5	50
		ODFBS5-3.5	50
		ODFBS10-3.5	10
Marking Tags (標記號)		DUC-TMF3.5	10 (側面 144 位)
		DUC-TM3.5	10 (正面 144 位)
Tool (工具)		DS2 (0.4 x 2.0mm)	

Push In Spring Clamp Ground Terminal Blocks 推入式彈片接地型接線座

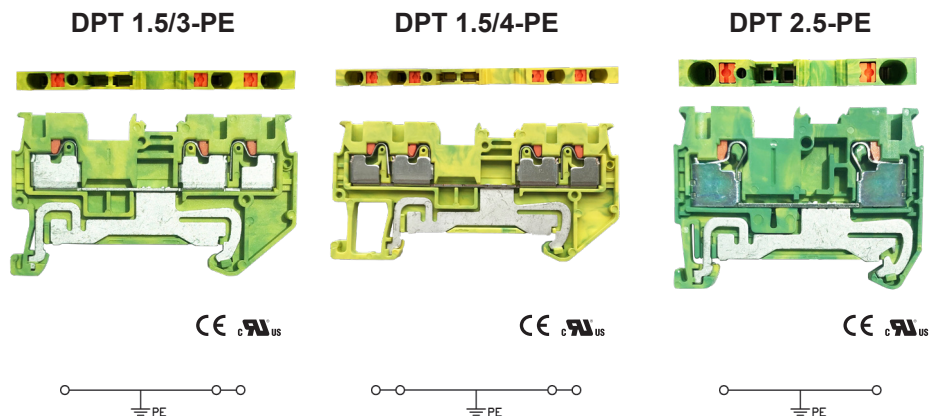

Specifications (產品規格)	1.5mm ²	1.5mm ²	2.5mm ²
Technical Data (技術參數)	Rated voltage / Rated current / Wire Size	Rated voltage / Rated current / Wire Size	Rated voltage / Rated current / Wire Size
UL	600V / AWG 26-14	600V / AWG 26-14	600V / AWG 26-12
CSA	600V / AWG 26-14	600V / AWG 26-14	600V / AWG 26-12
IEC	500V / 0.14-1.5mm ²	500V / 0.14-1.5mm ²	800V / 0.14-2.5mm ²
Insulating Impulse voltage withstand / Pollution degree (額定衝擊電壓 / 汙染等級)	6KV / 3	6KV / 3	8KV / 3
Insulation stripping length (mm) (剝線長度)	10mm	10mm	10mm
Material / Available Color (材質顏色)			
Rail Dimensions (導軌尺寸)	T / W / H (mm)	T / W / H (mm)	T / W / H (mm)
For TS35x 7.5	3.5 x 54.1 x 32	3.5 x 63.2 x 32	5.2 x 48.5 x 36.5
For TS35x 15	3.5 x 54.1 x 39.5	3.5 x 63.2 x 39.5	5.2 x 48.5 x 44
Accessories (附件)	Cat. No. Qty.	Cat. No. Qty.	Cat. No. Qty.
End Bracket (終端擋板)	SEW35 50	SEW35 50	SEW35 50
End Plate (擋板)	DD-PT1.5/3-DP 50	DD-PT1.5/4-DP 50	DD-PT2.5-DP 50
Comb Link (連接式聯接件)	ODFBS2-3.5 50 ODFBS3-3.5 50 ODFBS4-3.5 50 ODFBS5-3.5 50 ODFBS10-3.5 10	ODFBS2-3.5 50 ODFBS3-3.5 50 ODFBS4-3.5 50 ODFBS5-3.5 50 ODFBS10-3.5 10	ODFBS2-5 50 ODFBS3-5 50 ODFBS4-5 50 ODFBS5-5 50 ODFBS10-5 10
Marking Tags (標記號)	DUC-TMF3.5 10 (側面 144 位) DUC-TM3.5 10 (正面 144 位)	DUC-TMF3.5 10 (側面 144 位) DUC-TM3.5 10 (正面 144 位)	DUC-TMF5 10 (側面 96 位) DUC-TM5 10 (正面 96 位)
Tool (工具)	DS2 (0.4 x 2.0mm)	DS2 (0.4 x 2.0mm)	DS3 (0.4 x 3.5mm)

Push In Spring Clamp Ground Terminal Blocks 推入式彈片接地型接線座

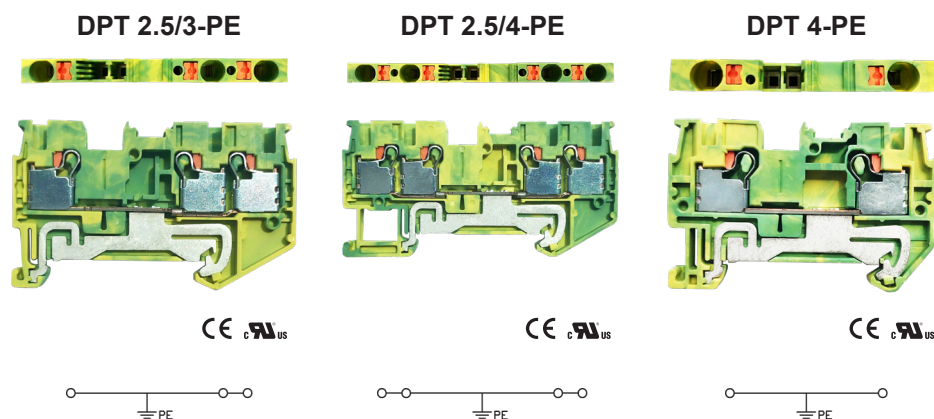

Specifications (產品規格)	2.5mm ²		2.5mm ²		4mm ²	
Technical Data (技術參數)	Rated voltage / Rated current / Wire Size		Rated voltage / Rated current / Wire Size		Rated voltage / Rated current / Wire Size	
UL	600V / AWG 26-12		600V / AWG 26-12		600V / AWG 24-10	
CSA	600V / AWG 26-12		600V / AWG 26-12		600V / AWG 24-10	
IEC	800V / 0.14-2.5mm ²		800V / 0.14-2.5mm ²		800V / 0.2-4mm ²	
Insulating Impulse voltage withstand / Pollution degree (額定衝擊電壓 / 汙染等級)	8KV / 3		8KV / 3		8KV / 3	
Insulation stripping length (mm) (剝線長度)	10mm		10mm		10mm	
Material / Available Color (材質顏色)						
Rail Dimensions (導軌尺寸)	T / W / H (mm)		T / W / H (mm)		T / W / H (mm)	
For TS35x 7.5	5.2 x 60.7 x 36.5		5.2 x 72.4 x 36.5		6.2 x 56.1 x 36.5	
For TS35x 15	5.2 x 60.7 x 44		5.2 x 72.4 x 44		6.2 x 56.1 x 44	
Accessories (附件)	Cat. No.	Qty.	Cat. No.	Qty.	Cat. No.	Qty.
End Bracket (終端擋板)	SEW35	50	SEW35	50	SEW35	50
End Plate (擋板)	DD-PT2.5/3-DP	50	DD-PT2.5/4-DP	50	DD-PT4-DP	50
Comb Link (連接式聯接件)	ODFBS2-5	50	ODFBS2-5	50	ODFBS2-6	50
	ODFBS3-5	50	ODFBS3-5	50	ODFBS3-6	50
	ODFBS4-5	50	ODFBS4-5	50	ODFBS4-6	50
	ODFBS5-5	50	ODFBS5-5	50	ODFBS5-6	50
	ODFBS10-5	10	ODFBS10-5	10	ODFBS10-6	10
Marking Tags (標記號)	DUC-TMF5	10 (側面 96 位)	DUC-TMF5	10 (側面 96 位)	DUC-TMF6	10 (側面 80 位)
	DUC-TM5	10 (正面 96 位)	DUC-TM5	10 (正面 96 位)	DUC-TM6	10 (側面 80 位)
Tool (工具)	DS3 (0.4 x 3.5mm)		DS3 (0.4 x 3.5mm)		DS3 (0.4 x 3.5mm)	

Push In Spring Clamp Ground Terminal Blocks 推入式彈片接地型接線座

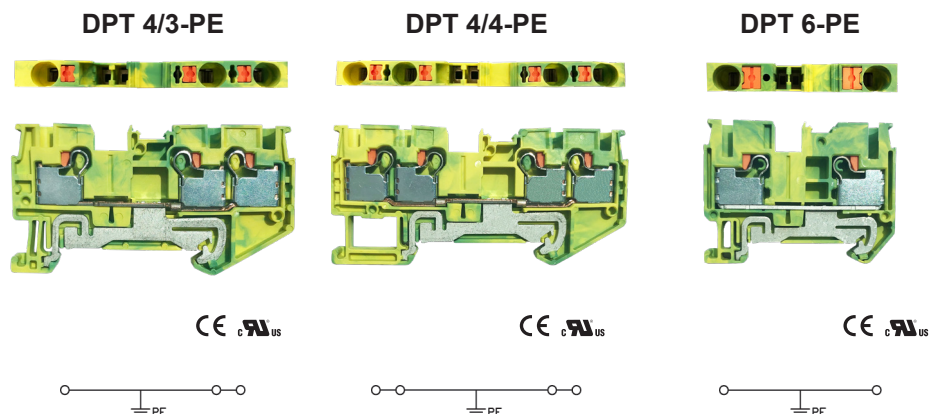

Specifications (產品規格)	4mm ²	4mm ²	6mm ²
Technical Data (技術參數)	Rated voltage / Rated current / Wire Size	Rated voltage / Rated current / Wire Size	Rated voltage / Rated current / Wire Size
UL	600V / AWG 24-10	600V / AWG 24-10	600V / AWG 20-8
CSA	600V / AWG 24-10	600V / AWG 24-10	600V / AWG 20-8
IEC	800V / 0.2-4mm ²	800V / 0.2-4mm ²	1000V / 0.5-6mm ²
Insulating Impulse voltage withstand / Pollution degree (額定衝擊電壓 / 汙染等級)	8KV / 3	8KV / 3	8KV / 3
Insulation stripping length (mm) (剝線長度)	10mm	10mm	12mm
Material / Available Color (材質顏色)			
Rail Dimensions (導軌尺寸)	T / W / H (mm)	T / W / H (mm)	T / W / H (mm)
For TS35x 7.5	6.2 x 66.5 x 36.5	6.2 x 77 x 36.5	8.2 x 57.7 x 43.5
For TS35x 15	6.2 x 66.4 x 44	6.2 x 77 x 44	8.2 x 57.7 x 51
Accessories (附件)	Cat. No. Qty.	Cat. No. Qty.	Cat. No. Qty.
End Bracket (終端擋板)	SEW35 50	SEW35 50	SEW35 50
End Plate (擋板)	DD-PT4/3-DP 50	DD-PT4/4-DP 50	DD-PT6-DP 50
Comb Link (連接式聯接件)	ODFBS2-6 50 ODFBS3-6 50 ODFBS4-6 50 ODFBS5-6 50 ODFBS10-6 10	ODFBS2-6 50 ODFBS3-6 50 ODFBS4-6 50 ODFBS5-6 50 ODFBS10-6 10	ODFBS2-8 50 ODFBS3-8 50 ODFBS4-8 50 ODFBS5-8 50 ODFBS10-8 10
Marking Tags (標記號)	DUC-TMF6 10 (側面 80 位) DUC-TM6 10 (正面 80 位)	DUC-TMF6 10 (側面 80 位) DUC-TM6 10 (正面 80 位)	DUC-TMF8 10 (側面 56 位) DUC-TM8 10 (正面 56 位)
Tool (工具)	DS3 (0.4 x 3.5mm)	DS3 (0.4 x 3.5cm)	DS4 (0.4 x 5.5mm)

Push In Spring Clamp Ground Terminal Blocks 推入式彈片接地型接線座

DPT 6/3-PE

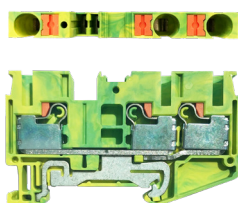

CE cULus

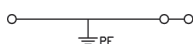

DPT 6/4-PE

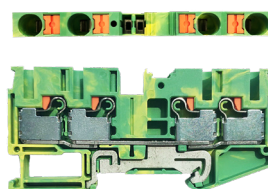

CE cULus

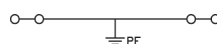

DPT 10-PE

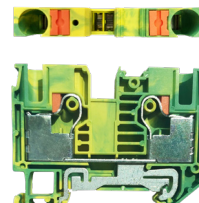

CE cULus

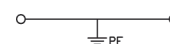

Specifications (產品規格)	6mm ²	6mm ²	10mm ²
Technical Data (技術參數)	Rated voltage / Rated current / Wire Size	Rated voltage / Rated current / Wire Size	Rated voltage / Rated current / Wire Size
UL	600V / AWG 20-8	600V / AWG 20-8	600V / AWG 20-6
CSA	600V / AWG 20-8	600V / AWG 20-8	600V / AWG 20-6
IEC	1000V / 0.5-6mm ²	1000V / 0.5-6mm ²	1000V / 0.5-10mm ²
Insulating Impulse voltage withstand / Pollution degree (額定衝擊電壓 / 污染等級)	8KV / 3	8KV / 3	8KV / 3
Insulation stripping length (mm) (剝線長度)	12mm	12mm	18mm
Material / Available Color (材質顏色)			
Rail Dimensions (導軌尺寸)	T / W / H (mm)	T / W / H (mm)	T / W / H (mm)
For TS35x 7.5	8.2 x 74.2 x 43.5	8.2 x 90.6 x 43.5	10.2 x 67.7 x 50.5
For TS35x 15	8.2 x 74.2 x 51	8.2 x 90.6 x 51	10.2 x 67.7 x 58
Accessories (附件)	Cat. No. Qty.	Cat. No. Qty.	Cat. No. Qty.
End Bracket (終端擋板)	SEW35 50	SEW35 50	SEW35 50
End Plate (擋板)	DD-PT6/3-DP 50	DD-PT6/4-DP 50	DD-PT10-DP 50
Comb Link (連接式聯接件)	ODFBS2-8 50 ODFBS3-8 50 ODFBS4-8 10 ODFBS5-8 50 ODFBS10-8 10	ODFBS2-8 50 ODFBS3-8 50 ODFBS4-8 10 ODFBS5-8 50 ODFBS10-8 10	ODFBS2-10 10 ODFBS5-10 10
Marking Tags (標記號)	DUC-TMF8 10 (側面 56 位) DUC-TM8 10 (正面 56 位)	DUC-TMF8 10 (側面 56 位) DUC-TM8 10 (正面 56 位)	DUC-TMF10 10 (側面 48 位) DUC-TM10 10 (正面 48 位)
Tool (工具)	DS4 (0.4 x 5.5mm)	DS4 (0.4 x 5.5mm)	DS5 (0.4 x 6.5mm)

Push In Spring Clamp Ground Terminal Blocks 推入式彈片接地型接線座

手机/微信: 13655187271 <http://www.decachina.com/>

DPT 10/3-PE

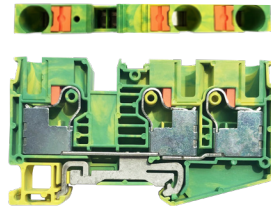

CE cULus

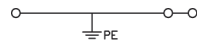

DPTN 16-PE

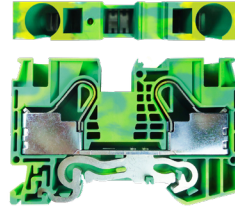

CE cULus

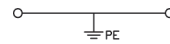

DPTN 16/3-PE

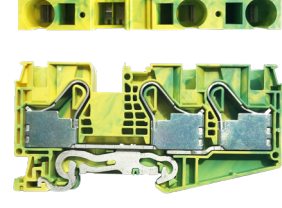

CE cULus

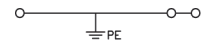

Specifications (產品規格)	10mm ²	16mm ²	16mm ²
Technical Data (技術參數)	Rated voltage / Rated current / Wire Size	Rated voltage / Rated current / Wire Size	Rated voltage / Rated current / Wire Size
UL	600V / AWG 20-6	600V / AWG 20-4	600V / AWG 20-4
CSA	600V / AWG 20-6	600V / AWG 20-4	600V / AWG 20-4
IEC	1000V / 0.5-10mm ²	1000V / 0.5-16mm ²	1000V / 0.5-16mm ²
Insulating Impulse voltage withstand / Pollution degree (額定衝擊電壓 / 汙染等級)	8KV / 3	8KV / 3	8KV / 3
Insulation stripping length (mm) (剝線長度)	18mm	18mm	18mm
Material / Available Color (材質顏色)			
Rail Dimensions (導軌尺寸)	T / W / H (mm)	T / W / H (mm)	T / W / H (mm)
For TS35x 7.5	10.2 x 88.9 x 50.5	12.2 x 77.6 x 51.5	12.2 x 104 x 51.5
For TS35x 15	10.2 x 88.9 x 58	12.2 x 77.6 x 59	12.2 x 104 x 59
Accessories (附件)	Cat. No. Qty.	Cat. No. Qty.	Cat. No. Qty.
End Bracket (終端擋板)	SEW35 50	SEW35 50	SEW35 50
End Plate (擋板)	DD-PT10/3-DP 50	DD-PTN16-DP 50	DD-PTN16/3-DP 50
Comb Link (連接式聯接件)	ODFBS2-10 10 ODFBS5-10 10	ODFBS2-12 10	ODFBS2-12 10
Marking Tags (標記號)	DUC-TMF10 10 (側面 48 位) DUC-TM10 10 (正面 80 位)	DUC-TMF12 10 (側面 40 位) DUC-TM12 10 (正面 40 位)	DUC-TMF12 10 (側面 40 位) DUC-TM12 10 (正面 40 位)
Tool (工具)	DS5 (0.4 x 6.5mm)	DS5 (0.4 x 6.5mm)	DS5 (0.4 x 6.5mm)

Push In Spring Clamp Ground Terminal Blocks 推入式彈片接地型接線座

DPTN 35-PE

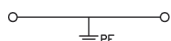
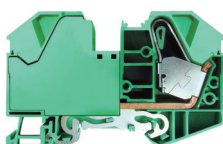

Specifications (產品規格)	35mm ²	
Technical Data (技術參數)	Rated voltage / Rated current / Wire Size	
UL	600V / AWG 14-2	
CSA	600V / AWG 14-2	
IEC	1000V / 2.5-35mm ²	
Insulating Impulse voltage withstand / Pollution degree (額定衝擊電壓 / 污染等級)	8KV / 3	
Insulation stripping length (mm) (剝線長度)	25mm	
Material / Available Color (材質顏色)		
Rail Dimensions (導軌尺寸)	T / W / H (mm)	
For TS35x 7.5	16 x 100 x 63.2	
For TS35x 15	16 x 100 x 70.7	
Accessories (附件)	Cat. No.	Qty.
End Bracket (終端擋板)	SEW35	50
End Plate (擋板)		
Comb Link (邊接式聯接件)	ODFBS2-16	10
Marking Tags (標記號)	DUC-TMF16	10 (側面 32 位)
	DUC-TM16	10 (正面 32 位)
Tool (工具)	DS5 (0.4 x 8.0mm)	

Push In Spring Clamp Ground Terminal Blocks 推入式彈片接地型接線座

DPTTB 1.5-PE

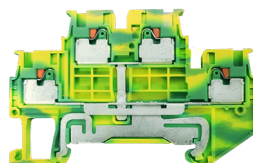

CE cULus

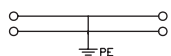

DPTTB 2.5-PE

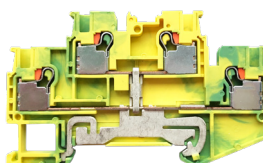

CE cULus



DPTTB 4-PE

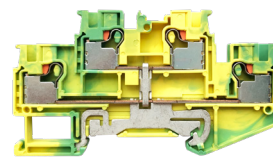

CE cULus

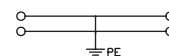

Specifications (產品規格)	1.5mm ²	2.5mm ²	4mm ²
Technical Data (技術參數)	Rated voltage / Rated current / Wire Size	Rated voltage / Rated current / Wire Size	Rated voltage / Rated current / Wire Size
UL	600V / AWG 26-14	600V / AWG 28-12	600V / AWG 24-10
CSA	600V / AWG 26-14	600V / AWG 28-12	600V / AWG 24-10
IEC	500V / 0.14-1.5mm ²	800V / 0.08-2.5mm ²	800V / 0.2-6mm ²
Insulating Impulse voltage withstand / Pollution degree (額定衝擊電壓 / 污染等級)	6KV / 3	8KV / 3	8KV / 3
Insulation stripping length (mm) (剝線長度)	10mm	10mm	10mm
Material / Available Color (材質顏色)			
Rail Dimensions (導軌尺寸)	T / W / H (mm)	T / W / H (mm)	T / W / H (mm)
For TS35x 7.5	3.5 x 65.4 x 42.9	5.2 x 78.8 x 47.6	6.2 x 85 x 47.5
For TS35x 15	3.5 x 65.4 x 50.4	5.2 x 78.8 x 55.5	6.2 x 85 x 55
Accessories (附件)	Cat. No. Qty.	Cat. No. Qty.	Cat. No. Qty.
End Bracket (終端擋板)	SEW35 50	SEW35 50	SEW35 50
End Plate (擋板)	DD-PTTB1.5-DP 50	DD-PTTB2.5-DP 50	DD-PTTB4-DP 50
Comb Link (邊接式聯接件)	無	無	無
Marking Tags (標記號)	DUC-TMF3.5 10 (側面 144 位) DUC-TM3.5 10 (側面 144 位)	DUC-TMF5 10 (側面 96 位) DUC-TM5 10 (正面 96 位)	DUC-TMF6 10 (側面 80 位) DUC-TM6 10 (側面 80 位)
Tool (工具)	DS2 (0.4 x 2.0mm)	DS3 (0.4 x 3.5mm)	DS3 (0.4 x 3.5mm)

COMBI Push In Type Plug In Connection 插拔式接線端

COMBI Push In Type Plug In Connection

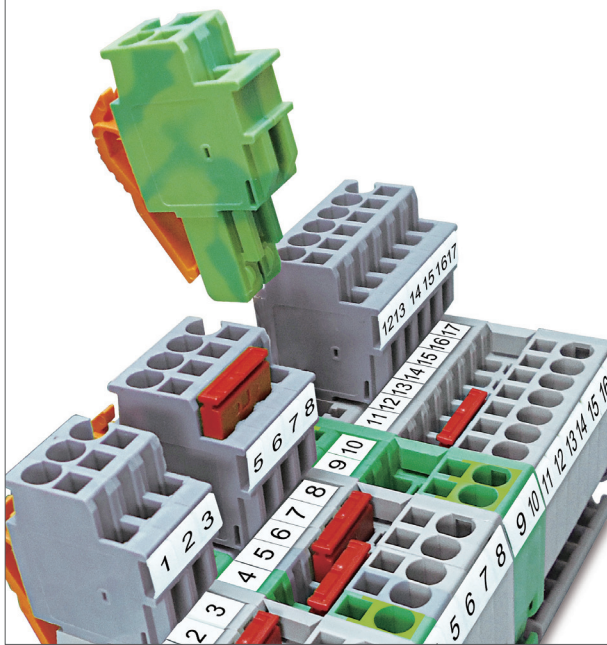

COMBI Push In Type Plug In Connection

- Space-saving design/plug-in connectors.
- Vibration proof anti-loosening wire connection with pre-stressed spring Clamp.
- Corrosion-proof terminal points.
- Easy for the extension of terminal connection.
- Easy handling and safe connection
- The push-in connectors for self-assembly provide ... solutions that users can implement themselves.
- The connector is assembled directly on site by snapping together single-position connector elements.
- The modular structure also enables individual self-assembly of the plugs and the couplings.

插拔式接線端之特性

- 節省空間之設計 / 插件連接方式
- 高強度壓力的彈片迫緊連接方式，具有抗震與防鬆的效果
- 抗腐蝕性佳（使用良好的金屬材料）
- 容易擴充及延伸性佳
- 操作簡便且連接處安全性高
- 推入式插件提供了用戶可自行安裝的解決方案
- 可依需求，利用插件相互卡接之特性組裝
- 模組化結構使用戶可自行組裝插件和配件

DST 2.5/1P-D

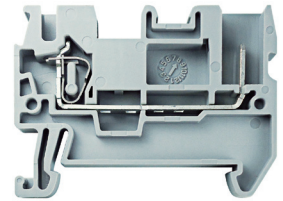







CE cULUS

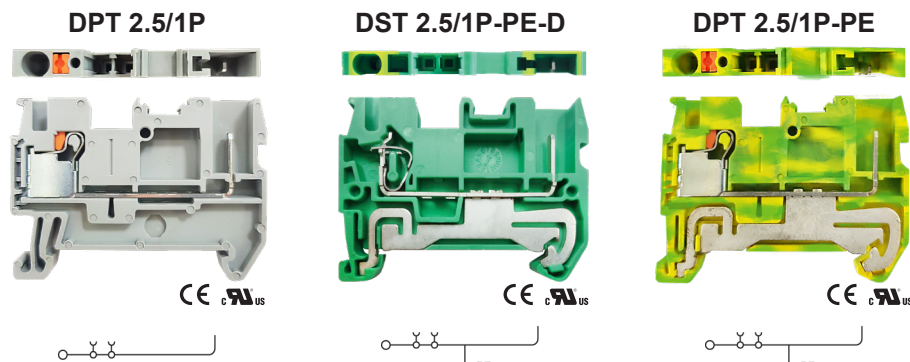

Specifications (產品規格)	2.5mm ²	
Technical Data (技術參數)	Rated voltage / Rated current / Wire Size	
UL	600V / 20A / AWG 28-12	
CSA	600V / 20A / AWG 28-12	
IEC	500V / 24A / 0.08-2.5mm ²	
Insulating Impulse voltage withstand / Pollution degree (額定衝擊電壓 / 汙染等級)	6KV / 3	
Insulation stripping length (mm) (剝線長度)	10mm	
Material / Available Color (材質顏色)	● ● ● ●	
Dimensions (尺寸)	T / W / H (mm)	
For TS35 x 7.5	5.2 x 48.8 x 36.9	
For TS35 x 15	5.2 x 48.8 x 44.4	
Accessories (附件)	Cat. No.	Qty.
End Bracket (終端擋板)	SEW35	50
End Plate (擋板)		
Comb Link (連接式聯接件)	ODFBS2-5	50
	ODFBS3-5	50
	ODFBS4-5	50
	ODFBS5-5	50
	ODFBS10-5	10
Marking Tags (標記號)	DCU-TMF5	10 (側面 96 位)
	DCU-TM5	10 (正面 96 位)
Tool (工具)	DS3	(0.4 x 3.5mm)

COMBI Push In Type Plug In Connection 插拔式接線端



Specifications (產品規格)	2.5mm ²		2.5mm ²		2.5mm ²	
Technical Data (技術參數)	Rated voltage / Rated current / Wire Size		Rated voltage / Rated current / Wire Size		Rated voltage / Rated current / Wire Size	
UL	600V / 20A / AWG 26-12		600V / 20A / AWG 28-12		600V / 20A / AWG 28-12	
CSA	600V / 20A / AWG 26-12		600V / 20A / AWG 28-12		600V / 20A / AWG 28-12	
IEC	500V / 24A / 0.14-2.5mm ²		500V / 24A / 0.08-2.5mm ²		500V / 24A / 0.14-2.5mm ²	
Insulating Impulse voltage withstand / Pollution degree (額定衝擊電壓 / 污染等級)	6KV / 3		6KV / 3		6KV / 3	
Insulation stripping length (mm) (剝線長度)	10mm		10mm		10mm	
Material / Available Color (材質顏色)	● ● ● ●		● ●		● ●	
Rail Dimensions (導軌尺寸)	T / W / H (mm)		T / W / H (mm)		T / W / H (mm)	
For TS35 x 7.5	5.2 x 48.8 x 36.8		5.2 x 48.8 x 36.9		5.2 x 48.8 x 36.8	
For TS35 x 15	5.2 x 48.8 x 44.6		5.2 x 48.8 x 44.4		5.2 x 48.8 x 44.6	
Accessories (附件)	Cat. No.	Qty.	Cat. No.	Qty.	Cat. No.	Qty.
End Bracket (終端擋板) 	SEW35	50	SEW35	50	SEW35	50
End Plate (擋板) 	DD-ST2.5-D	50	DD-ST2.5-DP	50	DD-ST2.5-DP	50
Comb Link (連接式聯接件) 	ODFBS2-5	50	ODFBS2-5	50	ODFBS2-5	50
	ODFBS3-5	50	ODFBS3-5	50	ODFBS3-5	50
	ODFBS4-5	50	ODFBS4-5	50	ODFBS4-5	50
	ODFBS5-5	50	ODFBS5-5	50	ODFBS5-5	50
	ODFBS10-5	10	ODFBS10-5	10	ODFBS10-5	10
Marking Tags (標記號) 	DUC-TMF5	10 (側面 96 位)	DUC-TMF5	10 (側面 96 位)	DUC-TMF5	10 (側面 96 位)
	DUC-TM5	10 (正面 96 位)	DUC-TM5	10 (正面 96 位)	DUC-TM5	10 (正面 96 位)
Tool (工具) 	DS3 (0.4 x 3.5mm)		DS3 (0.4 x 3.5mm)		DS3 (0.4 x 3.5mm)	

COMBI Push In Type Plug In Connection 插拔式接線端

COMBI Push In Type Plug In Connection

DSPB 2.5/XP (X=1~15)

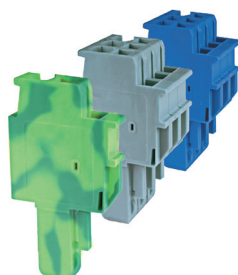

DPP-H2.5/XP

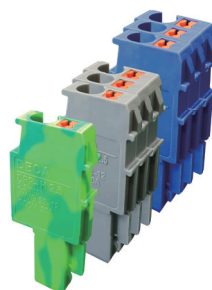

Specifications (產品規格)	2.5mm ²		2.5mm ²	
Technical Data (技術參數)	Rated voltage / Rated current / Wire Size		Rated voltage / Rated current / Wire Size	
UL	600V / 20A / AWG 28-12		600V / 20A / AWG 28-12	
CSA	600V / 20A / AWG 28-12		600V / 20A / AWG 28-12	
IEC	500V / 24A / 0.08-2.5mm ²		500V / 24A / 0.08-2.5mm ²	
Insulating Impulse voltage withstand / Pollution degree (額定衝擊電壓 / 污染等級)	6KV / 3		6KV / 3	
Insulation stripping length (mm) (剝線長度)	10mm		10mm	
Material / Available Color (材質顏色)	● ● ● ● ●		● ● ● ● ●	
Rail Dimensions (導軌尺寸)	T / W / H (mm)		T / W / H (mm)	
For TS35 x 7.5	X * 5.2 x 22.9 x 39.7		5.2 x 17 x 39.7	
Accessories (附件)	Cat. No.	Qty.	Cat. No.	Qty.
Snap-lock fitting Plate (鎖定片)	DPR2.5	50	DDPPH2.5	50
Comb Link (邊接式聯接件) 	ODFBS2-5	50	無	
	ODFBS3-5	50		
	ODFBS4-5	50		
	ODFBS5-5	50		
	ODFBS10-5	10		
Marking Tags (標記號) 	DUC-TMF5	10 (側面 96 位)	DUC-TMF5	10 (側面 96 位)
Tool (工具) 	DS3 (0.4 x 3.5mm)		DS3 (0.4 x 3.5mm)	

Strain relief / Snap-lock Fitting

Strain relief (DZP)

- Can be used in all connector versions
- The connector can be fixed using contact cable binders

Snap-lock Fitting (DPR2.5)

- Can be used in all connector versions
- Can be snapped into connector housing as an option

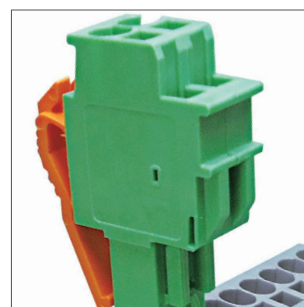

Technical Data		
Accessories (附件)	DZP	DPR
Material	PA66	PA66
Material / Available color (顏色)	Orange	Orange
Dimensions (外型尺寸)	T / W / H (mm)	T / W / H (mm)
	9.3 x 4.9 x 48.7	4.7 x 11.4 x 30.0
Terminal Blocks of application (應用軌道端子)	DSPB 系列 & DPP-H 系列	DSPB 系列 & DPP-H 系列
MOQ Minimum order quantity (最小訂購量)	50 PSC	50 PSC

Accessories 配件

End Plate

End Plate

- To enclose terminal blocks.

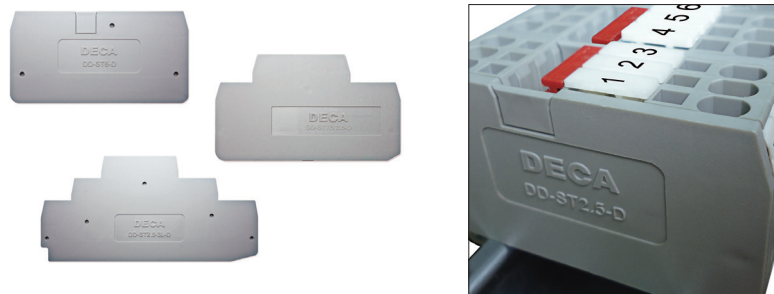

Type	DD-ST2.5-D	DD-ST2.5/3-D	DD-ST2.5/4-D	DD-ST4-D	DD-ST4/3-D	DD-ST4/4-D	DD-ST6-D
Terminal Block Model	DST1.5-D DST1.5-PE-D DST2.5-D DST2.5-PE-D DST2.5/1P-D DST2.5/1P-PE-D	DST1.5/3-D DST2.5/3-D DST2.5/3-PE-D DST2.5-MT-D	DST1.5/4-D DST2.5/4-D DST2.5/4-PE-D	DST4-D DST4-PE-D	DST4/3-D DST4/3-PE-D DST4-MT-D	DST4/4-D DST4/4-PE-D	DST6-D DST6-PE-D
Type	DD-ST6/3-D	DD-ST10-D	DD-ST10/3-D	DD-ST16-D	DD-ST16/3-D	DD-STTB2.5-D	DD-STTB2.5/3-D
Terminal Block Model	DST6/3-D DST6/3-PE-D	DST10-D DST10-PE-D	DST10/3-D DST10/3-PE-D	DST16-D DST16-PE-D	DST16/3-D DST16/3-PE-D	DSTTB2.5-D DSTTB2.5-PE-D	DSTTB2.5/3-D
Type	DD-ST2.5-3L-D	DD-STTB4-D	DD-PT1.5-D	DD-PT1.5/3-D	DD-PT1.5/4-D	DD-PT2.5-D	DD-PT2.5/3-D
Terminal Block Model	DST2.5-3L-D	DSTTB4-D	DPT1.5 DPT1.5-PE	DPT1.5/3 DPT1.5/3-PE	DPT1.5/4 DPT1.5/4-PE	DPT2.5 DPT2.5-PE	DPT2.5/3 DPT2.5/3-PE
Type	DD-PT2.5/4-D	DD-PT4/3-D	DD-PT4/4-D	DD-PT6-D	DD-PT6/3-D	DD-PT6/4-D	DD-PT10-D
Terminal Block Model	DPT2.5/4 DPT2.5/4-PE	DPT4/3 DPT4/3-PE	DPT4/4 DPT4/4-PE	DPT6 DPT6-PE	DPT6/3 DPT6/3-PE	DPT6/4 DPT6/4-PE	DPT10 DPT10-PE
Type	DD-PT10/3-D	DD-PTN16-D	DD-PTN16/3-D	DD-PTO2.5-D	DD-PTO2.5/3-D	DD-PTO2.5/4-D	DD-PTO4-D
Terminal Block Model	DPT10/3 DPT10/3-PE	DPTN16 DPTN16-PE	PTN16/3 DPTN16/3-PE	DPTO2.5 DPTO2.5-PE	DPTO2.5/3 DPTO2.5/3-PE	DPTO2.5/4 DPTO2.5/4-PE	DPTO4 DPTO4-PE
Type	DD-PTO4/3-D	DD-PTO4/4-D	DD-PTTB02.5-D	DD-PTO2.5-3L-D	DD-PTOIO2.5-S-3-D	DD-PTTB04-D	
Terminal Block Model	DPTO4/3 DPTO4/3-PE	DPTO4/4 DPTO4/4-PE	DPTTB02.5 DPTTB02.5-PE	DPTO2.5-3L DPTO2.5-3L-PE	DPTOIO2.5-S-3	DPTTB04 DPTTB04-PE	

Accessories 配件

Marking Tags

Marking Tags

- Easy installation & disassembly.
- Providing printing of various kinds of font.
- Firm printing (not easily falling off).
- Blank marking tags for marking by customer.
- Various kinds of specification upon request.

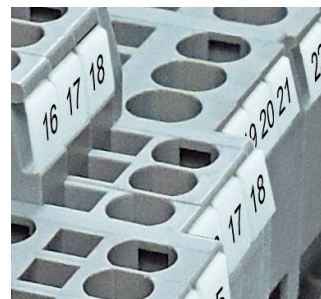
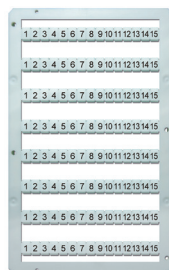

Type Terminal Block Model	DUC-TMF3.5	DUC-TMF4	DUC-TMF5	DUC-TMF6	DUC-TMF8	DUC-TMF10
DPT1.5 SERIES	•					
DST1.5 SERIES	•	•				
DST2.5 & DPT2.5 & DPTO2.5 SERIES	•	•	•			
DST4 & DPT4 & DPTO4 SERIES	•	•	•	•		
DST6 & DPT6 SERIES	•	•	•	•	•	
DST10 & DPT10 SERIES	•	•	•	•	•	•
DST16 & DPTN16 SERIES	•	•	•	•	•	•
DPTN35 SERIES	•	•	•	•	•	•
Type Terminal Block Model	DUC-TMF12	DUC-TMF16	DUC-TM3.5	DUC-TM4	DUC-TM5	DUC-TM6
DPT1.5 SERIES			•			
DST1.5 SERIES			•	•		
DST2.5 & DPT2.5 & DPTO2.5 SERIES			•	•	•	
DST4 & DPT4 & DPTO4 SERIES			•	•	•	•
DST6 & DPT6 SERIES			•	•	•	•
DST10 & DPT10 SERIES			•	•	•	•
DST16 & DPT16N SERIES	•		•	•	•	•
DPT35 SERIES	•	•	•	•	•	•
Type Terminal Block Model	DUC-TM8	DUC-TM10	DUC-TM12	DUC-TM16		
DPT1.5 SERIES						
DST1.5 SERIES						
DST2.5 & DPT2.5 & DPTO2.5 SERIES						
DST4 & DPT4 & DPTO4 SERIES						
DST6 & DPT6 SERIES	•					
DST10 & DPT10 SERIES	•	•				
DST16 & DPTN16 SERIES	•	•	•			
DPTN35 SERIES	•	•	•	•		

Accessories 配件

Comb Link

Comb Link

- Are used for external cross connecting terminal blocks.
- The links are insulated for shock proof.

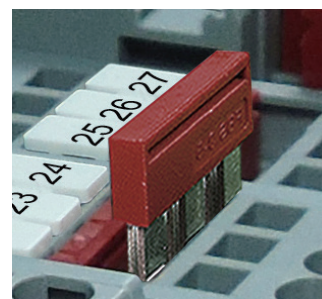
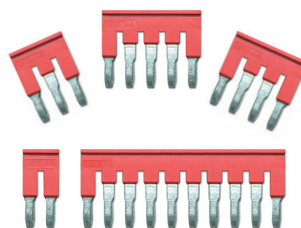

Type				
Terminal Block Model	ODFBS2-3.5 ODFBS3-3.5 ODFBS4-3.5 ODFBS5-3.5 ODFBS10-3.5	ODFBS2-4 ODFBS3-4 ODFBS4-4 ODFBS5-4 ODFBS10-4	ODFBS2-5 ODFBS3-5 ODFBS4-5 ODFBS5-5 ODFBS10-5	ODFBS2-6 ODFBS3-6 ODFBS4-6 ODFBS5-6 ODFBS10-6
DPT1.5 SERIES	•			
DST1.5 SERIES		•		
DST2.5 & DPT2.5 SERIES			•	
DST4 & DPT4 SERIES				•
Type				
Terminal Block Model	ODFBS2-8 ODFBS3-8 ODFBS4-8 ODFBS5-8 ODFBS10-8	ODFBS2-10 ODFBS5-10	ODFBS2-12	ODFBS2-16
DST6 & DPT6 SERIES	•			
DST10 & DPT10 SERIES		•		
DST16 & DPTN16 SERIES			•	
DPTN35 SERIES				•
Type				
Terminal Block Model	ODFBSO2-5 ODFBSO3-5 ODFBSO4-5 ODFBSO5-5 ODFBSO10-5	ODFBSO2-6 ODFBSO3-6 ODFBSO4-6 ODFBSO5-6 ODFBSO10-6		
DPTO2.5 SERIES	•			
DPTO4 SERIES		•		

Orbit Cuts off Utensil 軌道切斷器

Characteristic

Characteristic

- Guide apparatus for cutting a 90 degree angle exactly.
- Easy assembly on the workbench.
- Measure alignment metric and inch.
- Length stop: 1000mm.
- Burr-free cutting without loss.
- Shearing blade can be re-sharpened.
- Maintenance free.
- Labor saving due to better force transfer.

軌道切斷器 / 特性

- 九十度切割的前導裝置
- 易組裝於工作木台上
- 以公制及英制作量測校準
- 附帶卡尺可量測最大長度 :1000mm
- 無耗材的切割方式
- 裁刀可重覆研磨
- 免費維修
- 絕佳的省力切割方式

TSCU

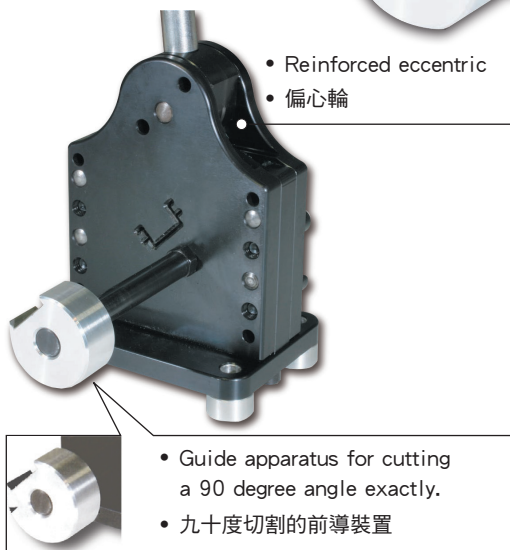
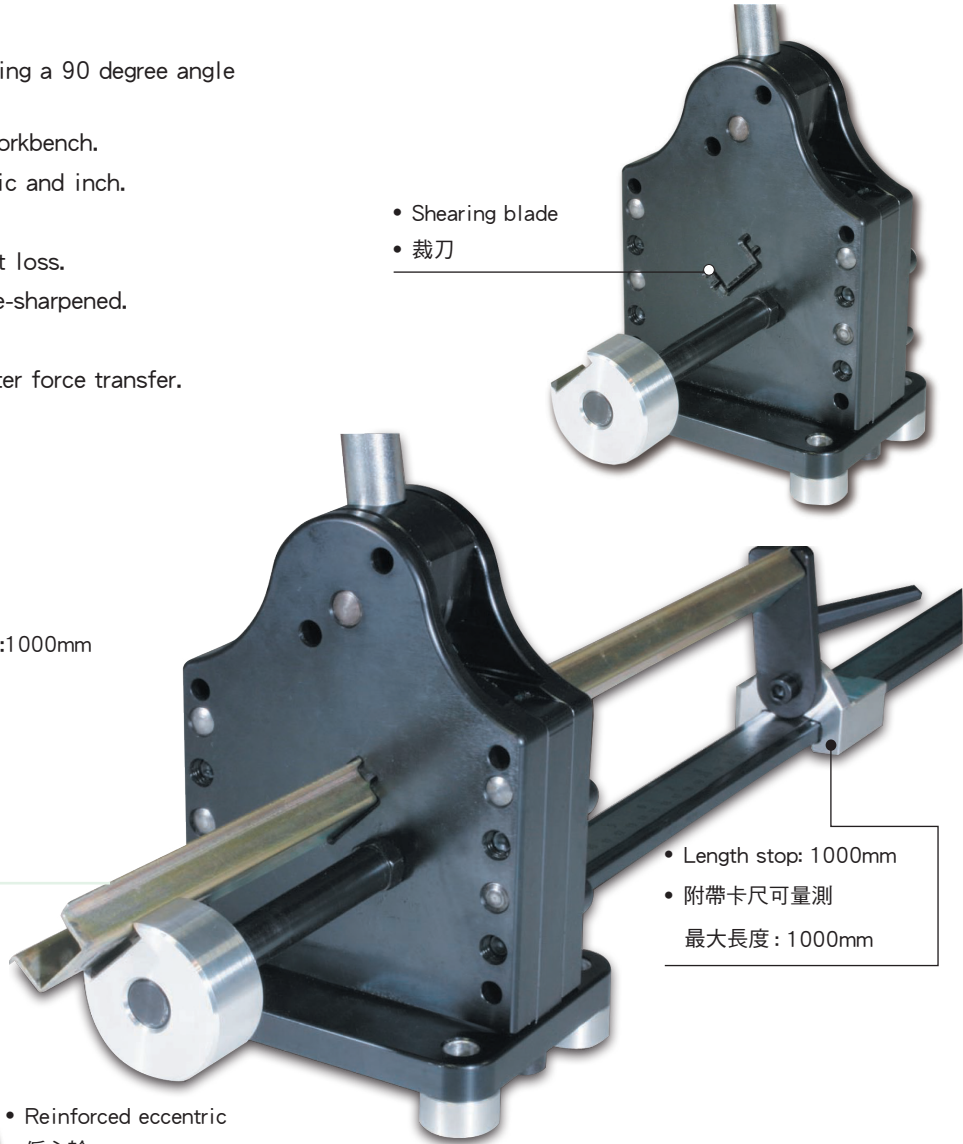

Carrier rails

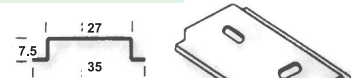

- Carrier rail 35mm / 7.5
ACC. to EN 50022
- 軌道寬度 35mm / 高度 7.5mm
符合 EN 50022 之標準



- Carrier rail 35mm / 15
ACC. to EN 50022
- 軌道寬度 35mm / 高度 15.0mm
符合 EN 50022 之標準